



GUAM POWER AUTHORITY  
AGANA, GUAM

SPECIFICATION No. E-020

REVISION: 3  
December 16, 2010

PREPARED BY THE ENGINEERING DEPT.

GUAM POWER AUTHORITY  
P.O. BOX 2977  
AGANA, GUAM 96932

TRANSMISSION & DISTRIBUTION SPECIFICATION

SPECIFICATION NO. E-020

FOR

**POLE MOUNTED DISTRIBUTION CAPACITORS**

EFFECTIVE DATE: 12/20/10

ISSUED: *[Signature]*

APPROVED: *[Signature]*



GUAM POWER AUTHORITY  
AGANA, GUAM

SPECIFICATION No. E-020

PAGE 1 OF 14

REVISION: 3  
December 16, 2010

PREPARED BY THE ENGINEERING DEPT.

## POLE MOUNTED DISTRIBUTION CAPACITORS

### TABLE OF CONTENTS

SECTION		PAGE
1.0	Scope .....	2
2.0	Applicable Publication.....	2
3.0	Deviations and Non-conformance Requirements .....	2
4.0	Submittals .....	2
5.0	Certified Laboratory Tests.....	3
6.0	Performance and Testing .....	4
7.0	Ratings.....	5
8.0	Design and Construction .....	5
9.0	Manufacturing.....	11
10.0	Quality Control .....	11
11.0	Packing and Shipping .....	11
	Capacitor Unit Data Sheet.....	13
	Figure A – Mounting Bracket.....	14

EFFECTIVE DATE: 12/20/10

ISSUED: 

APPROVED: 

 <p>GUAM POWER AUTHORITY AGANA, GUAM</p> <p>PREPARED BY THE ENGINEERING DEPT.</p>	<p>SPECIFICATION No. E-020</p>	<p>PAGE 2 OF 14</p> <p>REVISION: 3 December 16, 2010</p>
--	--------------------------------	--

1.0 SCOPE

- 1.1 This specification covers the electrical characteristics and design features for pole mounted, shunt capacitor equipment, single-phase units rated 7,970 volts, 60 Hz factory wired and assembled in an ungrounded WYE configuration for use on a 13,800 volt distribution system.
- 1.2 The capacitor is intended for use in tropical weather conditions with a corrosive sea air atmosphere, with wind strength of 155 mph and subject to moderate and severe earthquakes.

2.0 APPLICABLE PUBLICATION

- 2.1 The equipment specified herein shall be designed, manufactured, assembled, and tested in accordance with ANSI C37.66, ANSI C55.1, and NEMA CP1 including the latest revisions with respect to material, design, and tests.

3.0 DEVIATIONS AND NON-CONFORMANCE REQUIREMENTS



- 3.1 Deviations from this specification or changes in the material or design after the purchase order has been placed must be approved by the GPA Engineering department and acknowledged by a Purchase Order Amendment issued by GPA.
- 3.2 Units received with deviations or non-conformance that are not acknowledged per Section 3.1 are subject to rejection. The Supplier of rejected units is responsible for any corrective action as specified by GPA including but not limited to materials, labor and transportation necessary to dispose of or make the units conform to the specification.
- 3.3 Notification of defective units discovered before or after installation that are believed to be inherent to manufacturing problems or workmanship shall be made and forwarded to the Supplier. The description of the item, documentation of the problem and the described information, disposition, and/or follow-up (as appropriate) that GPA expects from the Supplier will be specified. The Supplier's response shall be made within thirty (30) days unless an extension is acknowledged and approved in writing by the GPA Manager of Engineering.

4.0 SUBMITTALS

- 4.1 Shop drawings indicating details of construction and the outline of all connectors shall be submitted to GPA Engineering for review and approval.

Information required includes:

- a. Mounting dimensions
- b. Rack dimensions

EFFECTIVE DATE: 12/20/10	ISSUED: 	APPROVED: 
--------------------------	---	---



- c. Location of terminals
- d. Weights
- e. Nameplate
- f. Connection diagram

Drawings showing metric measurements shall also indicate the equivalent English measurement. These drawings shall be made a part of the quotation.

#### 4.2 Supplementary Information

##### 4.2.1 Probability of Rupture and Time-Current Curves

Two sets of Probability of Rupture and Time-Current Curves shall be provided on standard log-log graph paper (Keuffel & Esser Co. #495259 or equivalent).

##### 4.2.2 Dielectric Materials and Instrument Transformers

Two sets of data for dielectric materials and for the instrument transformers shall be provided.

4.3 GPA shall be allowed two (2) weeks to review and approve drawings provided in Section 4.1 without affecting the shipping date. Delays in delivery due to drawings that are disapproved during this review period are the responsibility of the Supplier.

4.4 Drawings returned to the Supplier as approved shall be considered authorization to proceed with the work. The approval of GPA shall in no way abrogate the requirements of this specification.

4.5 Instruction books shall be furnished which shall contain the description of components, parts and accessories, detailed installation instructions, complete instructions covering operation and maintenance of equipment and a complete replacement parts list.

4.6 At least three (3) complete sets of drawings and instructions manuals shall be provided to GPA's Engineering Department prior to delivery.

#### 5.0 CERTIFIED LABORATORY TEST REPORTS

Certified tests shall be conducted in accordance with applicable standards and as listed in 6.0. The Supplier shall furnish two (2) copies of certified test reports for all tests to the GPA Manager of Engineering within two (2) weeks prior to delivery. This information shall include, but is not limited to the following:

5.1 Loss versus temperature curve between 40°C to 100°C.

EFFECTIVE DATE:

12/16/10

ISSUED:

[Signature]

APPROVED:

[Signature]



- 5.2 Loss versus time at 40°C curve between zero to 4000 hours, or to the point where the losses are constant.
- 5.3 Capacitance versus temperature curve between 40°C to 100°C.
- 5.4 Corona start and extinction voltage versus temperature curves between 40°C to 100°C.
- 5.5 Maximum temperature rise versus hours energized as per the thermal stability test.
- 5.6 Detailed design information (See attached Capacitor Unit Data Sheet).

## 6.0 PERFORMANCE AND TESTING

Capacitor units shall meet the performance and testing requirements specified in ANSI C55.1 (paragraphs 6.2 through 6.12) and NEMA CP1 (paragraphs 5.05 through 5.14) including the latest revisions with respect to material, design and tests unless otherwise specified below.

### 6.1 Dielectric Strength Test

The dielectric stress shall be such as to assure long capacitor life and high reliability. The maximum annual failure rate shall not exceed 0.5% during the first 1-1/2 years of energization.

### 6.2 Impulse Withstand Test

### 6.3 Thermal Stability Test

The temperature of the hottest spot inside the capacitor case shall not exceed 95°C when the capacitor is operated continuously at 110% of the rated voltage in a 40°C draft-free ambient environment.

### 6.4 Radio Influence Voltage Test

### 6.5 Voltage Decay Test

### 6.6 Case Rupture Test

### 6.7 Short-Time Overvoltage Test

### 6.8 Capacitance Test

### 6.9 Loss Test

EFFECTIVE DATE: 12/16/10

ISSUED: 

APPROVED: 



6.9.1 Acceptance statistical sampling methods may be used for this test if desired.

6.9.2 A plot of the capacitor losses at rated voltage and frequency at an ambient temperature of 40°C shall be made between zero and 4000 hours or to the point where losses are constant.

6.10 Discharge Resistor Test

6.11 Leak Test

6.12 Corona Starting Voltage

The internal corona starting voltage or ionization level shall not be less than 150% of rated voltage at 25°C. This requirement shall be met as follows:

6.12.1 The dissipation factor of the test specimen shall be measured and recorded with the dielectric temperature at 100°C.

6.12.2 After the dielectric temperature of the test specimen has returned to 25°C, the test specimen shall be placed in 25°C ambient temperature and alternately energized for five minutes at 150% voltage and de-energized for 25 minutes, a total of 60 times.

6.12.3 After completion of the test, the dissipation factor of the test specimen shall again be measured with its dielectric temperature at 100°C and recorded. This reading shall be made as soon as practicable and, in any case, not longer than 72 hours after completion of the energized test.

6.12.4 The final dissipation factor reading shall not exceed the initial reading by more than 10%.

6.12.5 Acceptable statistical sampling methods may be used for this test if desired.

## 7.0 RATINGS

Standard KVAR and voltage ratings for the capacitor units furnished individually or as part of factory assembled capacitor equipment are as follows:

<u>Single Phase KVAR</u>	<u>Voltage (V)</u>
150	7970
200	7970

## 8.0 DESIGN AND CONSTRUCTION

EFFECTIVE DATE:

12/10/10

ISSUED:

*[Handwritten signature]*

APPROVED:

*[Handwritten signature]*



### 8.1 Capacitor Banks

- 8.1.1 Capacitor banks shall consist of 3, 6, or 9 each 150 KVAR or 200 KVAR single-phase, fixed units as specified in the Purchase Order.
- 8.1.2 The capacitor-equipped, pole-mounted racks shall have sufficient strength such that, when mounted on the pole, they are capable of sustaining the application of a 200 pound load (with a safety factor of 2) at one end of the length-wise dimension of the rack without breaking or deforming. The opposite end shall also be capable of sustaining this load. The loads will not be applied simultaneously.
- 8.1.3 All pole-mounted capacitor banks shall be equipped with provisions for mounting lightning arrestors, capacitor switches, potential transformer and a junction box.
- 8.1.4 When required, a switched capacitor bank shall be provided with a surface-mounted control unit.

### 8.2 Capacitor Bank Wiring

- 8.2.1 Bank wiring shall be arranged so that neutral wiring is closest to the pole surface. Neutral wiring shall clear the surface of the pole by 6 inches.
- 8.2.2 All capacitor banks shall be wired for operation on a 13.8 kV system, with a floating neutral.
- 8.2.3 Wires connecting capacitor units and bushing terminals shall be bird-proof using covered wires and terminal caps.
  - 8.2.3.1 The bird proofing shall be made of material that is not subject to ultra-violet degradation.
  - 8.2.3.2 The bird proofing shall be light gray in color conforming to ANSI No. 70 (Munsell 5 BG 7.0/0.4).
- 8.2.4 The capacitor rack grounding provision shall not be bird-proof.

### 8.3 Capacitor Racks

- 8.3.1 Capacitor racks shall be welded, structural aluminum. All welds shall be full penetration.
- 8.3.2 Each rack shall be furnished with a connector for positive electrical grounding.

EFFECTIVE DATE:

12/16/10

ISSUED:

APPROVED:



- 8.3.3 Each rack shall have four 1-1/2" diameter, aluminum lifting eyes positioned for balanced lifting. Each eye shall be welded to the rack and shall be free from sharp edges.
- 8.3.4 Each rack shall have provisions to accept 150 or 200 KVAR capacitor tanks.
- 8.3.5 Each rack shall be furnished with the exact number of tanks as stated in the Purchase Order.
- 8.3.6 Each rack shall be free of fractures, cracking, or other imperfections.
- 8.3.7 Each rack shall have provisions to mount 3 single-phase capacitor switches, a potential transformer, and a junction box.
- 8.3.8 All the capacitor units, capacitor switches, potential transformers and junction box shall be pre-wired in the factory per the bank configuration. All the intra-rack connections shall be insulated and all live terminals shall be shielded by the insulation caps.
- 8.4 Mounting Brackets
- 8.4.1 Pole mounting brackets shall be welded, structural aluminum designed to reduce sway.
- 8.4.2 Brackets shall be designed to mount onto round concrete poles with diameters between 8 and 22 inches.
- 8.4.3 Mounting brackets shall have 11/16" holes to allow installation on pre-drilled concrete poles with a vertical, center to center mounting distance of 20 to 24 inches. The upper hole provision shall be fixed. The lower mounting provision shall be slotted 11/16 inch wide by 4 inches long. See Figure A for details.
- 8.5 Capacitor Unit Tanks
- 8.5.1 Standard tank material shall be made of 300 or 400 series stainless steel and resistant to a severely corrosive environment.
- 8.5.2 The tank, including the bushing seals, shall ensure that the capacitor will remain hermetically sealed throughout the life of the unit.
- 8.5.3 Outside Finish
- Each tank shall be coated with zinc chromate primer and the finish shall be a light gray color conforming to ANSI No. 70 (Munsell 5BG 7.0/0.4). The total external dry-film thickness of the paint shall be 3.5 mils minimum or equivalent protection as approved.

EFFECTIVE DATE:

12/16/10

ISSUED:

1/5/11

APPROVED:

[Signature]





#### 8.6 Capacitor Unit Dielectric Materials

8.6.1 The dielectric system shall consist of a solid insulation of synthetic film impregnated with a stable and PCB free dielectric fluid to provide high reliability and long life and is environmentally acceptable. A dielectric consisting of a synthetic film and paper combination may be accepted as an alternate.

#### 8.7 Capacitor Unit Bushings and Terminals

8.7.1 Two bushings shall be furnished with each capacitor unit. Bushings shall be made of glazed, wet-processed porcelain.

8.7.2 Porcelain bushing glaze shall be light gray in color conforming to ANSI 70 (Munsell 5 BG 7.0/0.4).

8.7.3 All leads shall be brought out through bushings with full electrical rating.

8.7.4 The bushing minimum creepage distance shall be 17 inches.

8.7.5 The minimum strike distance between phases shall be 6 ½ inches.

8.7.6 Bushing terminals shall be tin plated copper or bronze parallel groove type suitable for a minimum range of conductor sizes from No. 8 solid to and including No. 2 stranded copper.

8.7.7 Bushing seals shall have adequate mechanical strength and flexibility to withstand reasonable cantilever movement or impact without damage.

#### 8.8 Switched Capacitor Control Unit

For orders requiring the use of switched capacitors, the following requirements must be followed:

8.8.1 Stand-alone VAR Sensing Capacitor Bank Controller units must be included in the purchase order.

8.8.2 Controller units shall have local control actions based on VAR, temperature, neutral current, line voltage, and time of day. The units shall be capable of operating with any combination of local control actions.

EFFECTIVE DATE: 12/16/10

ISSUED: 

APPROVED: 



8.8.3 Control units shall provide data logging of line voltage, watts, and kVAR including the before and after operating voltage, kVAR and power factor direction. High and low voltage and adaptive (delta) voltage shall be available via the front panel user interface or a DNP point. The delta voltage can be calculated using the before and after operating voltage indicated in the data log.

8.8.4 Control units shall be fitted with status/data LED indicators.

8.8.5 Control unit enclosures shall be surface mounted, NEMA 4R, with utility seal and padlocking provisions.

#### 8.9 Capacitor switch

8.9.1 The capacitor switch shall be a single phase, electrically operated vacuum switch with close and latch capability. The switch shall be rated for up to 14.4 kV ungrounded WYE systems

#### 8.9.2 Rating

Maximum Design Voltage, kV	15.0
Nominal Operation Voltage, kV	14.4
Basic Insulation Level (BIL), kV	95
60 Hz Withstand Voltage, kV	
Dry, One Minute	50
Wet, Ten Minute	45
Continuous Current Rating, Amps	200
Load Interrupting Ability (Inductive), Amps	200
10-100% power factor	
Maximum capacitive current, Amps	200
Rated Asymmetrical Making Current, Amps	9000
Short Time Current, Amps	
Asymmetric (10) cycle	9000
Symmetric (1/2 second)	6000
Symmetric (1 second)	4500
Rated High Frequency Peak	
Transient Making Current, Amps	12000
Rated Transient Inrush Frequency, Hz	6000

EFFECTIVE DATE:

12/16/10

ISSUED:

1-2

APPROVED:

JR



### 8.9.3 Duty Cycle

200 Amps	400 operations
100 Amps	400 operations
50 Amps	400 operations

8.9.4 The switch shall be equipped with vacuum interruption and the vacuum bottle shall be encapsulated in the solid polymer. The solid polymer shall have high surface tracking resistance and can withstand Ultra – Violet exposure without degradation.

8.9.5 Fluorocarbons shall not be used in the manufacturing of the switch.

8.9.6 There shall be no porcelain used on the external portion of the switch. The switch shall not chip, crack or shatter.

8.9.7 A manual operating handle shall be provided as standard with load break opening and closing capabilities. The manual operating handle may also be used for closing into fault currents up to the rated making current.

8.9.8 The switch shall be operable in any mounting orientation.

8.9.9 Electrical operations shall be accomplished utilizing a motor which charges a spring to open and close the contacts. The current requirement for opening or closing shall not exceed 3 Amps

8.9.10 The switch shall withstand a minimum of 30,000 mechanical operations. An operation is defined as an open and close cycle.

### 8.10 Potential Transformer

8.10.1 A potential transformer shall be supplied as required for operating the switches and the controller

8.10.2 The potential transformer shall be of oil type, single phase.

8.10.3 The potential transformer shall be mounted on the rack with the switches.

### 8.11 Current Sensor

8.11.1 A current sensor shall provide current readings to the controller.

8.11.2 The current sensor shall be compatible with the controller and designed for outdoor use.

EFFECTIVE DATE: 12/16/10

ISSUED: 

APPROVED: 



#### 8.12 Junction Box

8.12.1 A junction box and terminal shall be provided for connecting controllers, the potential transformer, and switches.

8.12.2 The junction box shall be made of stainless steel and sealed and suitable for outdoor application.

8.12.3 The terminal blocks shall be made of heavy duty grade suitable for outdoor use.

### 9.0 MANUFACTURING

#### 9.1 Nameplate

Each capacitor shall have a nameplate made of 300 or 400 stainless steel. The information shown on the nameplate shall be as specified in NEMA Publication No. CP1 and ANSI Standard C55.1. Each capacitor rack nameplate shall have all required information plus the weight of the complete assembly.

#### 9.2 Non-PCB Indicator

A weather-resistant label or decal shall be located on each end of each capacitor rack or tank to signify biodegradable dielectric fluid.

### 10.0 QUALITY CONTROL

10.1 The Supplier shall have a quality control program to ensure compliance with the requirements of this specification. The program shall be documented and available for GPA's review if requested.

10.2 Documentation of the quality control program shall indicate where in the production and manufacturing process the quality checks are taken, describe the purpose of the checks, and describe the nature of the check, i.e. if check is visual only or if electrical or mechanical testing is used.

10.3 The supplier shall certify that the compositions of all materials used are sufficient to meet the requirements of this specification.

### 11.0 PACKING AND SHIPPING

EFFECTIVE DATE:

12/16/10

ISSUED:

APPROVED:



GUAM POWER AUTHORITY  
AGANA, GUAM

SPECIFICATION No. E-020

PAGE 12 OF 14

REVISION: 3  
December 16, 2010

PREPARED BY THE ENGINEERING DEPT.

- 11.1 The Supplier shall have adequate work and inspection instructions for handling, interim storage, preservation, packaging, and shipping to protect the quality of the capacitor and prevent damage, loss and deterioration.
- 11.2 The capacitor rack equipment shall be shipped in an open type vehicle to facilitate unloading by use of a forklift.
- 11.3 The capacitor shall be securely blocked to prevent shifting during transit.

EFFECTIVE DATE: 12/16/10

ISSUED: *[Signature]*

APPROVED: *[Signature]*



CAPACITOR UNIT DATA SHEET

1. Catalog Number \_\_\_\_\_
2. Capacitor Unit Drawing Number \_\_\_\_\_
3. Volts \_\_\_\_\_ KVAR \_\_\_\_\_ No. of Phases \_\_\_\_\_
4. Weight Per Unit \_\_\_\_\_
5. Impulse (BIL), kV \_\_\_\_\_
6. Case Material \_\_\_\_\_ Finish \_\_\_\_\_ Color \_\_\_\_\_
7. Bushing Color \_\_\_\_\_
8. Impregnating  
Liquid \_\_\_\_\_
9. Foil \_\_\_\_\_
10. Dielectric Thickness:
  - a. Paper: No. of Sheets \_\_\_\_\_ Thickness of each: \_\_\_\_\_ Mils
  - b. Film: No. of Sheets \_\_\_\_\_ Thickness of each: \_\_\_\_\_ Mils
  - c. Total Dielectric Thickness: \_\_\_\_\_ Mils
11. Dielectric Thickness:
  - a. Paper: \_\_\_\_\_ V/Mil
  - b. Film: \_\_\_\_\_ V/Mil
12. Corona start and extinction voltage versus Dielectric temperature obtained from actual test.  
See Curve \_\_\_\_\_
  - a. Inception Voltage at 25°C, \_\_\_\_\_ % Rated Voltage
  - b. Inception Voltage at -25°C, \_\_\_\_\_ % Rated Voltage
  - c. Minimum Inception Voltage throughout \_\_\_\_\_ % of Rated Voltage Temperature range.
13. Volts per section at rated voltage: \_\_\_\_\_
14. Case rupture curve: \_\_\_\_\_
15. Capacitor Make-up: Series Sections: \_\_\_\_\_ Parallel Sections: \_\_\_\_\_
16. Maximum temperature rise per Stability Test NEMA CP1-5.07 (ambient temperature of 45°C)
  - a. Internal Hot Spot, °C \_\_\_\_\_ See Curve \_\_\_\_\_
  - b. Internal Hot Spot, °C \_\_\_\_\_ See Curve \_\_\_\_\_
17. Dielectric Loss Watts:
  - a. Dielectric Loss Watts/KVAR (avg.) \_\_\_\_\_ at 40°C
  - b. Dielectric Loss Watts/KVAR (max.) \_\_\_\_\_ at 40°C
  - c. Dielectric Loss Watts/KVAR (min.) \_\_\_\_\_ at 40°C

EFFECTIVE DATE: 12/10/10

ISSUED: [Signature]

APPROVED: [Signature]

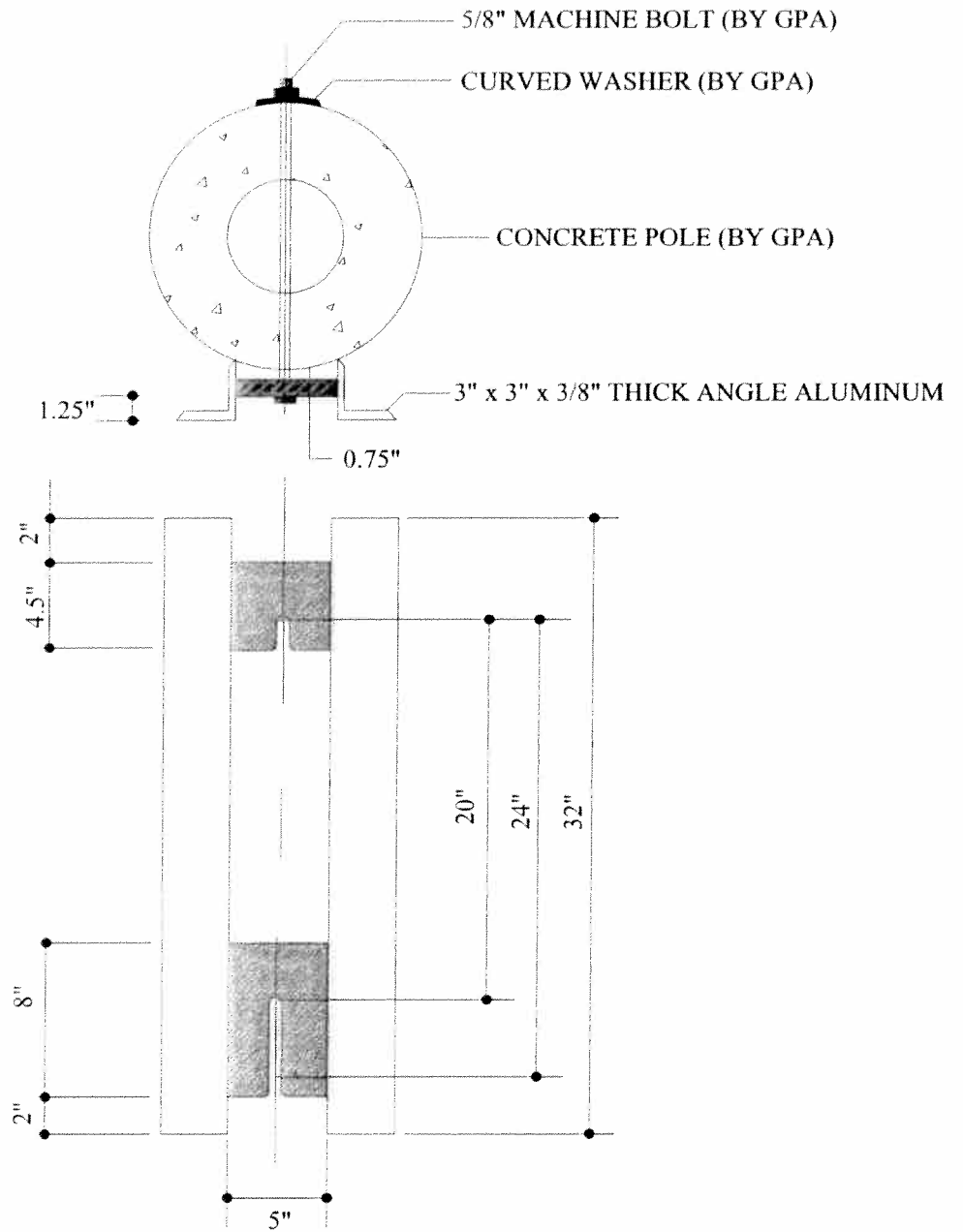

Figure A  
Mounting Bracket

EFFECTIVE DATE: 2/10/10

ISSUED: [Signature]

APPROVED: [Signature]