



JOSEPH T. DUENAS  
Chairman



JOHN M. BENAVENTE, P.E.  
General Manager

Telephone Nos. (671) 648-3054/55 or Facsimile (671) 648-3165

Accountability . Impartiality . Competence . Openness . Value

INVITATION FOR BID (IFB) NO.: GPA-093-17  
DESCRIPTION: Pole, Concrete, 35 Ft, Class B

**SPECIAL REMINDERS TO PROSPECTIVE BIDDERS**

Bidders are reminded to read the Sealed Bid Solicitation and Instructions, and General Terms and Conditions attached to the IFB to ascertain that all of the following requirements checked below are submitted in the bid envelope, one (1) original, in duplicate, at the date and time for bid opening.

(XX) BID GUARANTEE (no less than 15% of total bid) May be in the form;  
(NOTE: Cashier's Check or Certified Check Refunds will ONLY be made out to the name of the Bidder.)

Reference #11 on the General Terms and Conditions:

- a. Cash, Bank Draft, Cashier's Check or Certified Check
- b. Letter of Credit or
- c. Surety Bond – Valid only if accompanied by:
  - 1. Current Certificate of Authority issued by the Insurance Commissioner;
  - 2. Power of Attorney issued by the Surety to the Resident General Agent;
  - 3. Power of Attorney issued by two (2) major officers of the Surety to whomever is signing on their behalf.

( ) STATEMENT OF QUALIFICATION;

( ) SAMPLES;

(XX) BROCHURES/DESCRIPTIVE LITERATURE; (Shall provide detailed literature on items offered)

(XX) AFFIDAVIT OF DISCLOSURE OF MAJOR SHAREHOLDERS;

(XX) NON-COLLUSION AFFIDAVIT;

(XX) NO GRATUITIES OR KICKBACKS AFFIDAVIT;

(XX) ETHICAL STANDARDS AFFIDAVIT;

(XX) WAGE DETERMINATION AFFIDAVIT;

(XX) RESTRICTIONS AGAINST SEX OFFENDERS AFFIDAVIT;

Note: The above Affidavits must comply with the following requirements:

- a. The affidavit must be signed within 60 days of the date the bid is due;
- b. Date of signature of the person authorized to sign the bid and the notary date must be the same.
- c. First time affidavit must be an original – If copy, indicate Bid Number/Agency where original can be obtained.

(XX) OTHER REQUIREMENTS:

A Guam Business License and/or Contractor's License with proof of Employer Identification Number (EIN) is not required in order to provide a proposal for this engagement, but is a pre-condition for entering into a contract with the Authority. Bidders MUST comply with PL 26-111 dated June 18, 2002, PL 28-165 dated January 04, 2007 and Wage Determination under the Service Contract Act ([www.wdol.gov](http://www.wdol.gov)). Additionally, upon award the successful bidder must provide to GPA the most recently issued Wage Determination by the US Dept. of Labor.

The reminder must be signed and returned in the bid envelope together with the bid. Failure to comply with the above requirements will mean a disqualification and rejection of the bid.

On this \_\_\_\_\_ day of \_\_\_\_\_, 2017, I, \_\_\_\_\_, authorized representative of \_\_\_\_\_ acknowledge receipt of this special reminder to prospective bidders with the above referenced IFB.

\_\_\_\_\_  
Bidder Representative's Signature

INVITATION FOR BID

ISSUING OFFICE:  
Guam Power Authority  
Procurement Management Materials Supply  
GPA Central Office, 1<sup>st</sup> Floor  
Gloria B. Nelson Public Service Building  
688 Route 15  
Mangilao, Guam 96913

*Leelectra* 8/15/17  
*[Signature]*  
JOHN M. BENAVENTE, P.E. DATE  
General Manager

DATE ISSUED: 08/22/2017  
08/29/2017 BID INVITATION NO.: GPA-093-17  
BID FOR: Pole, Concrete, 35 FT, Class B  
SPECIFICATION: See Attached  
DESTINATION: See Attached  
REQUIRED DATE: 8 Weeks ARO

INSTRUCTIONS TO BIDDERS:

INDICATE WHETHER:  INDIVIDUAL  PARTNERSHIP  CORPORATION  
INCORPORATED IN: \_\_\_\_\_

This bid shall be submitted in duplicate and sealed to the issuing office above no later than (Time) 2:00 P.M.  
Date: 09/06/2017 and shall be publicly opened. Bid submitted after the time and date specified above  
shall be rejected. See attached General Terms and Conditions and Sealed Bid Solicitation for details.

The undersigned offers and agrees to furnish within the time specified, the articles and services at the price stated opposite  
the respective items listed on the schedule provided, unless otherwise specified by the bidder. In consideration to the  
expense of the Government in opening, tabulating, and evaluating this and other bids, and other considerations, the  
undersigned agrees that this bid remain firm and irrevocable within one hundred twenty (120) calendar days from the date  
opening to supply any or all of the items which prices are quoted.

NAME AND ADDRESS OF BIDDER: \_\_\_\_\_ SIGNATURE AND TITLE OF PERSON  
AUTHORIZED TO SIGN THIS BID: \_\_\_\_\_  
\_\_\_\_\_  
\_\_\_\_\_  
\_\_\_\_\_

AWARD: CONTRACT NO.: \_\_\_\_\_ AMOUNT: \_\_\_\_\_ DATE: \_\_\_\_\_

ITEM NO(S). AWARDED: \_\_\_\_\_  
\_\_\_\_\_  
\_\_\_\_\_

CONTRACTING OFFICER:

JOHN M. BENAVENTE, P.E. DATE  
General Manager

NAME AND ADDRESS OF CONTRACTOR: \_\_\_\_\_ SIGNATURE AND TITLE OF PERSON  
\_\_\_\_\_  
\_\_\_\_\_  
\_\_\_\_\_

INVITATION FOR BID NO.: GPA-093-17

Requisition No.: 30763

NO.	DESCRIPTION	QTY.	U/I	U/P:	T/P:
-----	-------------	------	-----	------	------

1.0	Pole, Concrete, 35 FT, Class (B) As per GPA Specification No.: E-035, Rev. 2 GPA Index No.: SSOP1103	100	Each	\$ _____	\$ _____
-----	--	-----	------	----------	----------

Each pole shall bear indented markings located 5 feet above the ground hole and in line with the center of gravity mark and ground hole. This birthmark shall include the following:

- \*Supplier's Identity Mark
- \*Month and Year of Manufacture
- \*Pole Height
- \*Pole Class
- \*Batch or Lot Number Identification

The Supplier shall also provide a mark indicating the longitudinal center of gravity of each pole and lifting mark for erection.

Substitute of stenciling or similar methods of marking for indent birthmark is NOT acceptable and shall be cause for rejection. Suppliers shall obtain approval of their marking methods.

The birthmark shall be 2 inch in diameter white porcelain tile by 1/4 inch thick with blue lettering, embedded in the pole and flush with exterior surface.

The center of gravity mark shall be a 3/4 inch diameter red porcelain tile by 1/4 inch thick embedded in the pole and flush with exterior surface.

Structural calculations and other submittal data as specified in E-035, Revision 2 must be submitted to GPA Engineering PRIOR to pole fabrication. Bidder shall provide a statement of compliance with GPA E-035 Revision 2 in the bid proposal. Bidder must also provide a statement in the bid proposal that all submittals and design calculations sealed by a Professional Engineer shall be provided to and approved by GPA Engineering prior to manufacture of poles. GPA Engineering shall also conduct pole testing prior to acceptance and delivery.

Bidder shall also be responsible for airfare expenses, ground transportation, hotel lodging and meals for two (2) GPA Representatives.

Final pole acceptance shall be in compliance with the bending and breaking test criteria (S.O.P. No. SP-135).

**NOTE:**

Notwithstanding the fact that this contract was written by one (1) party, it will be construed that it was written by two (2) parties.

All deviations shall be identified referencing the Section and Sub-Section(s) from the attached GPA Specification.

REMARKS / DEVIATIONS:

---



---



---



---

INVITATION FOR BID NO.: GPA-093-17

Requisition No.: 30763

NO.	DESCRIPTION	QTY.	U/I	U/P:	T/P:
	8 Weeks ARO Upon Completion of Inspection Testing - <b>DELIVERY REQUIREMENT</b>				

Any delivery extension for this specific bid shall not be granted due to on-going and/or scheduled projects.

TO BE COMPLETED BY BIDDER:

MANUFACTURED BY: \_\_\_\_\_

BRAND NAME: \_\_\_\_\_

PLACE OF ORIGIN: \_\_\_\_\_

EXPORT ABROAD: \_\_\_\_\_

TIME OF DELIVERY AFTER RECEIPT OF PURCHASE ORDER: \_\_\_\_\_

Specifications Reviewed By:

 8/1/17

Reuben C. Ulloa Date  
Inventory Management Officer

 GUAM POWER AUTHORITY HAGATNA, GUAM PREPARED BY THE ENGINEERING DEPARTMENT	SPECIFICATION E-035	Page 1 of 53
		January 15, 2013
		REV. 2



GUAM POWER AUTHORITY  
POST OFFICE BOX 2977  
HAGATNA, GUAM 96910

TRANSMISSION & DISTRIBUTION SPECIFICATION

Specification No. E-035

For

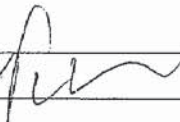
**CLASS A (SELF-SUPPORTING) and CLASS B (GUYED)  
CONCRETE POLES  
FOR TRANSMISSION AND DISTRIBUTION SYSTEMS**

EFFECTIVE DATE: 1/31/13	ISSUED: 	APPROVED: 
-------------------------	---	---

 <b>GUAM POWER AUTHORITY HAGATNA, GUAM</b>	<b>SPECIFICATION E-035</b>	Page 2 of 53
		January 15, 2013
		REV. 2
PREPARED BY THE ENGINEERING DEPARTMENT		

CLASS A and CLASS B CONCRETE POLES  
FOR TRANSMISSION AND DISTRIBUTION SYSTEMS  
TABLE OF CONTENTS

SECTION	PAGE
1.0 SCOPE:	4
2.0 APPLICABLE PUBLICATIONS:	4
3.0 DEVIATION AND NON-CONFORMANCE REQUIREMENTS:	5
4.0 SUBMITTALS:	6
5.0 DESIGN:	7
6.0 PRODUCTS:	8
7.0 PROVISIONS FOR GROUNDING:	9
8.0 SAMPLING AND TESTING:	10
9.0 QUALITY CONTROL:	11
10.0 FABRICATION:	11
11.0 POLE ACCEPTANCE TESTS:	16
12.0 BIRTHMARK:	17
13.0 SHIPPING AND DELIVERY REQUIREMENTS:	18
APPENDIX A1-A 45 FOOT CLASS A CONCRETE POLE	19
APPENDIX A1-B 55 FOOT CLASS A CONCRETE POLE	20
APPENDIX A2-A 35 FOOT CLASS B CONCRETE POLE	21
APPENDIX A2-B 45 FOOT CLASS B CONCRETE POLE	22
APPENDIX A2-C 45 FOOT CLASS B CONCRETE POLE	23
APPENDIX A3 DESIGN CRITERIA	24
APPENDIX A4-A CLASS A LOADING SET-UP	27
APPENDIX A4-B 45 FOOT CLASS A DESIGN DATA	28
APPENDIX A4-C 55 FOOT CLASS A DESIGN DATA	29
APPENDIX A4-D CLASS B LOADING SET-UP	30
APPENDIX A4-E 35 FOOT and 45 FOOT CLASS B DESIGN DATA	31
APPENDIX A4-F 55 FOOT CLASS B DESIGN DATA	33
APPENDIX A5 ABBREVIATIONS, NOTATIONS AND DEFINITIONS	37

EFFECTIVE DATE: 1/31/13	ISSUED: 	APPROVED: 
-------------------------	---	---

 GUAM POWER AUTHORITY HAGATNA, GUAM PREPARED BY THE ENGINEERING DEPARTMENT	<b>SPECIFICATION E-035</b>	Page 3 of 53
		January 15, 2013
		REV. 2

SECTION		PAGE
APPENDIX B	POLE TEST SET-UP	38
APPENDIX B1	CLASS A TEST LOADS	39
APPENDIX B2	CLASS B TEST LOADS	40
APPENDIX C	CONCRETE POLE TEST PROCEDURE	41
APPENDIX D	BASIC DESIGN CRITERIA	43
APPENDIX E	CONCRETE POLE INSPECTION AND TEST FORMS	44
APPENDIX F	TESTING OF CONCRETE SAMPLE FORM	52

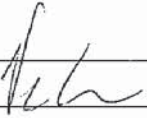
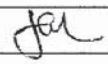
EFFECTIVE DATE: 1/31/13	ISSUED: 	APPROVED: 
-------------------------	---	---

 <p>GUAM POWER AUTHORITY HAGATNA, GUAM</p>	<p><b>SPECIFICATION E-035</b></p>	<p>Page 4 of 53</p>
		<p>January 15, 2013</p>
		<p>REV. 2</p>
<p>PREPARED BY THE ENGINEERING DEPARTMENT</p>		

PRESTRESSED SPUN  
CONCRETE POLE SPECIFICATIONS



1.0 SCOPE:

- 1.1. This specification covers the design, construction and delivery of prestressed spun concrete pole for use on GPA electric transmission and distribution systems.
- 1.2. Poles are to be used in high humidity, high corrosion salt-air environment subject to severe earthquakes and typhoon winds.
  - 1.2.1 Wind speeds of 155 miles per hour (sustained) and 170 mph (3 second gust)
  - 1.2.2 Earthquake loading per International Building Code -- 2009 .
- 1.3 Poles are to be installed in soil foundations or in concrete foundations.

2.0 APPLICABLE PUBLICATIONS: The publications listed below form a part of this specification to the extent referenced. The publications are referred to in the text by basic designation only. The latest edition shall always be used.

Substitute standards may be used for those listed below provided they have equal or superior requirements. Such standards must be submitted to GPA for review and approval.

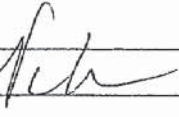
- 2.1. American Concrete Institute (ACI) Publications:
  - 211.1 Recommended Practice for Selecting Proportions for Normal and Heavyweight Concrete
  - 214 Recommended Practice for Evaluation of Strength Test Results of Concrete
  - 318 Building Code Requirements for Reinforced Concrete
- 2.2. American Society for Testing and Materials (ASTM) Publications:
  - A82 Cold-drawn Steel Wire for Concrete Reinforcement
  - A416 Uncoated Seven-Wire Stress-Relieved Strand for Prestressed Concrete
  - A421 Uncoated Stress Relieved Steel for Prestressed Concrete
  - A496 Steel Wire, Deformed for Concrete Reinforcement
  - A615 Deformed and Plain Billet-Steel Bar for Concrete Reinforcement
  - A641 Zinc Coated (Galvanized) Carbon Steel Wire (Metric)
  - A706 Low Alloy Steel Deformed Bars for Concrete Reinforcement
  - A996 Axial-Steel Deformed and Plain Bars for Concrete Reinforcement
  - C33 Concrete Aggregates
  - C39 Compressive Strength of Cylindrical Concrete Specimen
  - C131 Standard Test Method for Resistance to Degradation of Small-Size Coarse Aggregate by Abrasion and Impact in the Los Angeles Machine

EFFECTIVE DATE: 1/31/13	ISSUED: 	APPROVED: 
-------------------------	---	---





 <p><b>GUAM POWER AUTHORITY</b> HAGATNA, GUAM</p> <p>PREPARED BY THE ENGINEERING DEPARTMENT</p>	<p><b>SPECIFICATION E-035</b></p>	Page 5 of 53
		January 15, 2013
		REV. 2

- C143 Test for Slump of Portland Cement Concrete
- C150 Portland Cement
- C172 Sampling Freshly Mixed Concrete
- C260 Air-Entraining Admixtures for Concrete
- C289 Testing Potential Alkali-Silica Reactivity of Aggregates
- C494 Chemical Admixtures for Concrete
- C881 Epoxy-Resin-Base Bonding Systems for Concrete
- C1089 Standard Specifications for Spun Cast Prestressed Concrete Poles
- 2.3. American Welding Society (AWS) Publication:
  - D1.1 Recommended Procedures for Welding, Reinforcing Steel, Metal Inserts, and Connections in Reinforced Concrete Construction
  - D1.4 Structural Welding Code - Reinforcing Steel
- 2.4. Prestressed Concrete Institute (PCI) Publication:
  - MNL-116 Manual for quality control for plants and production of precast prestressed concrete products
  - MNL -116 Tendon prestressing to be in accordance with applicable sections of this publication
- 2.5 American National Standards Institute (ANSI) C2, 2012 National Electric Safety Code (NESC) Part 2 Safety Rules for Overhead Lines
  - Section 23 Clearances
  - Section 24 Grades of Construction
  - Section 25 General Loading Requirements
  - Section 26 Strength Requirements
- 2.6 29GAR – Public Works
  - 1301 General
- 2.7 International Building Code 2009
- 2.8 Industrial Fasteners Institute (IFI)
  - Fastener Standards
- 2.9 American Society of Civil Engineers/Prestressed Concrete Institute (ASCE/PCI) Joint Committee on Concrete Poles:
  - Guide for the Design of Prestressed Concrete Poles

**3.0 DEVIATION AND NON-CONFORMANCE REQUIREMENTS:**

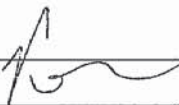
- 3.1. Provisions indicated by asterisks, (e.g. \*3.4\* below), describe submittals which must be included with the bid proposal. Failure to comply is a basis for rejection of the bid.

EFFECTIVE DATE: 1/21/13	ISSUED: 	APPROVED: 
-------------------------	---	---

 <b>GUAM POWER AUTHORITY</b> <b>HAGATNA, GUAM</b> PREPARED BY THE ENGINEERING DEPARTMENT	<b>SPECIFICATION E-035</b>	Page 6 of 53
		January 15, 2013
		REV. 2

- 3.2. All deviations from this specification including changes in design or materials after bid award must be approved by the GPA and acknowledged by a Purchase Order Amendment issued by GPA. If the deviations are not approved, the unit or units are considered to be non-binding.
- 3.3. Units received with deviations or non-conformance which are not acknowledged per Section 3.2 are subject to rejection. The Supplier of rejected units is responsible for any corrective action including, but not limited to all materials, labor, and transportation charges necessary to dispose of or to make the units conform to the specification.
- \*3.4.\* Statement of Compliance - the Supplier shall provide a signed statement in the bid proposal verifying that the products being supplied fully comply with the specifications and drawings. The Supplier shall provide all preliminary design drawings and design calculations required in this specification at the time of the bid, which will be approved by GPA prior to the award of the contract and the manufacture of the poles. Items not in full compliance with the specification and drawings will be identified with a description of the deficiency and any proposed substitutions. Items not in full compliance with the specifications and drawings must be approved by the GPA Engineering Department, as described in Section 3.2. Failure to comply with this requirement will result in the units being rejected.

**4.0 SUBMITTALS:**

- 4.1. **Shop Drawings:** Shop Drawings indicating details of construction shall be submitted to GPA for review prior to fabrication. Refer to Section 5 design calculations to be submitted to GPA Engineering.

Information required include:

- a. Birth marks and longitudinal center of gravity mark.
- b. Elevation view of each pole type.
- c. Section and details to indicate quantities and position of prestressing steel, reinforcing steel, spiral steel, inserts, steel strand lifting loops, through holes, etc.
- d. Location and sizes of all openings and holes to be cast in the poles.
- e. Storage, transportation and erection support points.
- f. Dimensions and finishes.
- g. Pole classifications A or B.
- h. Shop drawings shall be certified by a Professional Structural Engineer.
- i. Pole design calculations shall be certified by a Professional Structural Engineer.

Partial submittals will not be acceptable and will be returned without review. Submittals shall include the manufacturer's name, project specification and paragraph reference, applicable industry and technical society publication references, design calculations, detail and other information to establish contract compliance of each item the Supplier proposes to furnish.

- 4.2. **Certified Laboratory Test Reports:** Certified copies of the reports of all tests and equipment required in referenced publications or otherwise specified herein, shall be submitted to GPA. The material testing shall have been performed within one (1) year of submittal of test reports for approval, by an independent laboratory approved by GPA.

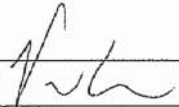
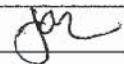
EFFECTIVE DATE: 1/31/13	ISSUED: 	APPROVED: 
-------------------------	---	---

 <b>GUAM POWER AUTHORITY</b> HAGATNA, GUAM PREPARED BY THE ENGINEERING DEPARTMENT	<b>SPECIFICATION E-035</b>	Page 7 of 53
		January 15, 2013
		REV. 2

Test reports on previously tested material shall be accompanied by notarized certificates from the manufacturer and approved laboratory, certifying that the previously tested materials is of the same type, quality, manufacturer, and make as proposed for use in this project. Certified material test reports in accordance with applicable codes are required for the following:

- a. Cement
- b. Concrete mix design
- c. Reinforcing steel
- d. Prestressing steel
- e. Materials for curing concrete
- f. Concrete admixtures
- g. Aggregates
- h. Water
- i. Certificate of calibration for hydraulic jack
- j. Certificate of calibration for dynamometer

4.3. The pole manufacturer must have approved submittals available during site inspection.

**5.0 DESIGN:**

- 5.1. Refer to Appendices A1-A, A1-B, A2-A, A2-B, A2-C, and "D" of this specification for specific requirements and detailed information related to design criteria, pole lengths, minimum reinforcement clearance, minimum wall thickness, hole dimensions, insert placements and spacings and maximum pole circumferences.
- 5.2. Poles shall be designed per the design criteria as specified in Appendix D and shall satisfy the strength requirements indicated in the Appendices (A4-B and A4-C for self-supporting poles and A4-E and A4-F for guyed poles). Submit detailed calculations including sections, elevations and loading conditions for each pole. Nomenclature, symbols and abbreviations used in the calculations shall be fully explained in English. The English System of units shall be used (pounds, feet, etc.). The submittal shall include the stress-strain curve of the prestressing steel strands. As a minimum, stresses for all design conditions shall be checked at ground level, at mid-level and at any point on the pole where a number of prestressed strands change. See Appendix B for calculation of prestress losses.
- 5.3. Wind loading of 155 mph (sustained), 170 mph (3 second gust) at 33 feet above the ground and earthquake loading per International Building Code - 2009 shall be used in the design.
- 5.4. Pole designs shall be prepared from the attached configuration drawings and design loads. The pole shall be capable of withstanding all specified loading cases including wind on pole and secondary stresses from foundation deflection and rotation, and from vertical loads acting on lateral pole deflection (P-delta effect). Design of poles for these secondary stresses shall not consider the possible restraining effect of conductors or shield wires. The pole shall withstand the loads without failure and without exceeding any specified deflection limitations.
- 5.6. Poles shall withstand the loading conditions, including specified load factors. The pole design shall include allowances for loads from handling, transportation, and erection without failure, permanent deformation, or damage to the pole when handled according to the manufacturer's instructions.

EFFECTIVE DATE:	1/31/13	ISSUED:		APPROVED:	
-----------------	---------	---------	---	-----------	---

 <b>GUAM POWER AUTHORITY HAGATNA, GUAM</b> PREPARED BY THE ENGINEERING DEPARTMENT	<b>SPECIFICATION E-035</b>	Page 8 of 53
		January 15, 2013
		REV. 2

- 5.7. Poles shall be designed by the ultimate strength method as explained in ACI 318. Poles shall be designed so that the ultimate strength of the pole exceeds the required strength calculated from the factored loads applied to the pole including wind on the pole, as specified by GPA. The point of fixity on the pole shall be considered at groundline or other location as specified with the embedment depths shown on the attached drawings.
- 5.8. Poles shall be designed so that the cracking strength of the pole exceeds the required strength calculated from the service loads applied to the pole, as specified by GPA.
- 5.9. Poles that are subjected to a permanent unbalanced lateral load (such as unguayed angle or unguayed deadend structures), or any other structures specified by GPA, shall be designed so that the zero tension strength of the pole exceeds the required strength calculated from the service loads applied to the pole, as specified by GPA.
- 5.10. Poles shall be designed in combination with the appropriate column load applied along the pole axis as a result of the guys, braces, etc. When guys are specified, the ultimate load in the guy shall not exceed 65 percent of the rated breaking strength of the guy for all load cases. For design purposes, guy wire modulus of elasticity shall be specified by GPA. The manufacturer shall advise GPA if the specified guy size is inappropriate prior to submitting a bid.
- 5.11. Poles shall be designed to withstand a one-point (tilting) pickup during erection. The manufacturer shall include the weight of the pole with all insulators and hardware attached. The poles shall be designed for two-point pickup for horizontal handling. All pickup points shall be clearly shown on the fabrication drawings. All poles shall be designed for the loads generated from handling and erecting without exceeding the cracking moment capacity of the poles.
- 5.12. The design of each pole shall be performed using the applicable codes and standards listed in Section 2.0 of this specification.
- 5.13. Pole design and design calculations shall be the responsibility of the manufacturer.

**6.0 PRODUCTS:**

- 6.1. Concrete Mix: Design concrete mix in accordance with ACI 211.1 The concrete shall have a minimum 28 day compressive strength of 6,000 pounds per square inch with a maximum aggregate size of ¾ inch and a maximum water-cement ratio of 0.40. Higher strengths and lower water-cement ratios are encouraged and may be necessary to offset steel cover requirements.
- 6.2. Cement: The cement shall be either Type I or II Portland cement conforming to ASTM C 150. All cement for exposed concrete surfaces shall be of the same manufacturer.
- 6.3. Water: Water, including free moisture and water in the aggregates, shall be fresh, clean, potable and free from undesirable amounts of oils, acids, alkalis, salts, organic materials, or other deleterious substances in amounts harmful to concrete and steel.
- 6.4. Aggregates: ASTM C 33. Obtain all aggregates for exposed concrete surfaces from one source. Aggregates shall be free from any substances which may be deleteriously reactive with the alkalis in the cement. (Three-fourths inch maximum aggregate size unless indicated otherwise).

EFFECTIVE DATE: 1/21/13	ISSUED: 	APPROVED: 
-------------------------	---	---

 GUAM POWER AUTHORITY HAGATNA, GUAM PREPARED BY THE ENGINEERING DEPARTMENT	<b>SPECIFICATION E-035</b>	Page 9 of 53
		January 15, 2013
		REV. 2

- 6.4.1. Fine aggregate shall be a natural sand, consisting of clean, strong, hard, durable uncoated particles conforming to ASTM C33, and all specifications included therein. The aggregate shall be well graded from No. 4 to No. 200 sieve. Deleterious substances shall not comprise more than 5 percent of the sample.
- 6.4.2. Coarse aggregate shall be clean, tough, crushed stone conforming to ASTM C33, and all specifications included therein. The aggregate shall be well graded from a 3/4 inch to a No. 8 sieve with no more than 5 percent of the sample passing a No. 8 sieve. Deleterious substance content shall not exceed 5 percent of the sample. Resistance to abrasion shall not exceed 40 percent as tested in conformance with ASTM C131. Absorption shall be less than 4 percent or aggregate shall be saturated with water prior to use in concrete.
- 6.4.3. Aggregate shall be tested in accordance with ASTM C289 to determine an alkali-aggregate reaction. Crushed rock or partially crushed rock shall be the source of the aggregate.
- 6.5. Admixtures: ASTM C 260 (air entraining); ASTM C 494 (chemical). All admixtures shall have prior approval of GPA, shall be from a single manufacturer, and shall be certified by the manufacturer to be free of chlorides.
- 6.6. The chemical properties of materials used in the manufacture of the poles shall meet the requirements of the applicable ASTM specification and be such that noticeable pyrite staining or efflorescence due to sulfates and/or chlorides does not occur.
- 6.7. Concrete mix design requirements listed above can be altered with GPA's approval.
- 6.8. Reinforcement: Prestressing steel mechanical properties, reinforcing steel and spiral reinforcement shall be in accordance with the applicable ASTM specifications listed in Section 2.0 of this specification.
  - 6.8.1. Reinforcing Bars: ASTM A 615, Grade 60 or approved equal. Welded splices shall be in accordance with AWS D1.4.
  - 6.8.2. Spiral Wire: ASTM A 82, cold-drawn steel or approved equal.
  - 6.8.3. Prestressing Steel: High tensile stress-relieved wire stand. ASTM A 416, Grade 270 or approved equal. The wire shall be free of substances that would prevent bond to the concrete.

**7.0 PROVISIONS FOR GROUNDING**

Poles shall be supplied with an approved method for grounding.

- 7.1. Preinstalled grounding provisions shall include the following:
  - 7.1.1. Stranded copper conductor minimum size #2 AWG.
  - 7.1.2. Copper or copper alloy connection block located where ground sleeves are shown in the Appendices (A1-A, A1-B, A2-A, A2-B and A2-C).
- 7.2. Design
  - 7.2.1. Ground wires shall be continuous run, with no splicing, inside the hollow space of the pole and not embedded in the concrete. The wires shall be welded to the connection

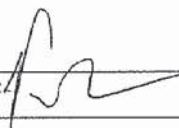
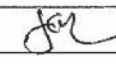
EFFECTIVE DATE: 1/31/13	ISSUED: 	APPROVED: 
-------------------------	---	---

 GUAM POWER AUTHORITY HAGATNA, GUAM	SPECIFICATION E-035	Page 10 of 53
		January 15, 2013
		REV. 2
PREPARED BY THE ENGINEERING DEPARTMENT		

blocks provided or connected (not soldered) so as to prevent disconnection of the wire from the connection block.

- 7.2.2. Ground sleeves shall be placed in the middle between the 11/16 inch and 13/16 inch holes, unless shown otherwise. Ground sleeves holes shall be 2 inches in diameter. The ground sleeve located at the bottom of the pole is to be placed two feet above the groundline, unless otherwise indicated.
- 7.2.3. Connection blocks shall be installed at all ground sleeves locations to allow for ease of external connection of copper conductor sizes between #6 AWG to #2 AWG. The connection block shall be rigid designed to prevent from being dislodged from the pole.
- 7.2.4. A minimum of one longitudinal steel strand shall be bonded electrically to the ground wire at the top and bottom of the pole. Each bond shall be located within the top 2 feet of the pole and at one foot below the groundline. This bonding system shall be noncorrosive and shall be approved by GPA.

**8.0 SAMPLING AND TESTING:**

- 8.1. **General:** Samples and tests are to be made by and at the supplier's expense. The tests shall be performed on calibrated equipment, as required by MNL-116, by an independent commercial testing laboratory or, if approved by GPA, at the precaster's quality control laboratory. Compressive strength tests made prior to tensioning of the prestressing strands may be performed in the precaster's quality control laboratory. Certified test reports shall include all test data and results.
- 8.2. **Concrete Tests:** For manufacturers that batch their own concrete, the manufacturer shall take a minimum of 8 concrete test cylinders per representative sample. Samples shall be taken at minimum intervals of one per day, one per 25 cubic yards of concrete batched, and with each change in raw material supplier for batches used to make GPAs' poles. The test cylinders for each day's concrete that is batched shall be tested for compressive strength as follows:
  - a. Minimum of one for determining release strength;
  - b. Minimum of one at 7 days;
  - c. Minimum of one at 14 days; and
  - d. Minimum of one at 28 days.
- 8.3. For manufacturers that acquire concrete from outside sources, test cylinders shall be taken from each truck load of concrete and tested in accordance with this specification.
- 8.4. Test cylinders shall be prepared, then cured in the same curing environment as the pole itself or cured per the applicable ASTM specification.
- 8.5. **Slump:** Determine slump in accordance with ASTM C 143.
- 8.6. Concrete used on GPAs' poles shall have the quality to meet the design strength and other requirements included in this specification.
- 8.7. Upon request from GPA, the manufacturer shall provide GPA statistical data on concrete strength quality in accordance to applicable ACI and ASTM specifications. A correlation

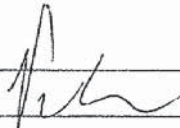
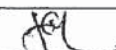
EFFECTIVE DATE: 1/21/13	ISSUED: 	APPROVED: 
-------------------------	---	---

	<b>SPECIFICATION E-035</b>	Page 11 of 53
		January 15, 2013
		REV. 2
PREPARED BY THE ENGINEERING DEPARTMENT		

factor between rodded cylinders and the spun concrete, substantiated by test data, shall be provided.

**9.0 QUALITY CONTROL:**

- 9.1. The Supplier shall have a quality control program to assure compliance with the requirements of this specification. The program shall be documented and a copy provided to GPA at the time of bid submittals.
- 9.2. Particular attention must be paid to the materials used. It is required that:
  - 9.2.1. The Manufacturer will make the required test cylinders of the concrete used, protect and cure the cylinders in accordance with ACI 318 and perform the compressive tests on these specimens to ensure compliance with the strength requirements for tendon release and final compressive strength of the concrete.
  - 9.2.2. The reinforcement materials shall be clean and made free of oil and scale.
- 9.3. The Supplier shall ensure that the water used in mixing concrete shall be clean potable and free from harmful amounts of silt, oil, acids, alkalies, salts, and other detrimental substances.
- 9.4. Notification of defective poles discovered before or after installation believed to be inherent to the manufacturing process or design shall be forwarded to the Supplier. This notice will include documentation of the problem and suggestions for follow-up actions expected by GPA. Supplier's response shall be made in thirty (30) days unless an extension is acknowledge and approved in writing by the GPA Manager of Engineering.

**10 FABRICATION:**

**10.1. TOLERANCES AND PERMISSIBLE VARIATIONS:**

- 10.1.1. **CROSS SECTIONAL DIMENSIONS:** Cross sectional dimensions shall not deviate from design dimensions by more than ¼-inch. Wall thickness shall not deviate from the design dimension by more than ¼ inch or +20 percent – 10 percent, whichever is greater.
- 10.1.2. **LONGITUDINAL DIMENSIONS:** Longitudinal dimensions shall not deviate from the design dimensions by more than 1 inch, or ¼ inch per 10 feet.
- 10.1.3. The pole shall have a uniform taper from top to butt.
- 10.1.4. Deviation of the pole from straightness is allowed in one plane and one direction only. A straight line joining the edge of the pole at the butt and the edge of the pole at the top shall not be further from the surface of the pole at any point by more than the accumulated value of 0.25 inches for each 10 feet of length between the two ends. The detensioning operation shall be performed in a manner to keep the prestressing forces symmetrical.
- 10.1.5. There shall be a minimum specified wall thickness of 2.5 inches of spun concrete at all points along the pole.

EFFECTIVE DATE: 1/31/13	ISSUED: 	APPROVED: 
-------------------------	---	---

 GUAM POWER AUTHORITY HAGATNA, GUAM PREPARED BY THE ENGINEERING DEPARTMENT	SPECIFICATION E-035	Page 12 of 53
		January 15, 2013
		REV. 2

- 10.1.6. **LOCATION OF HARDWARE AND HOLES:** The hole locations on the pole as to be placed as indicated in the Appendices and shall not deviate more than 1/16 inch from the nominal design dimensions. The hole spacing shall not deviate more than 1/16 inch from the nominal design dimensions where there is a pattern of holes for material to be bolted on at a later date.
- 10.1.7. GPA shall have the right to reject any pole in which the performance of a bolted connection may be reduced due to the lack of a clearly preformed or drilled hole.
- 10.1.8. The hydraulic jack equipment used to tension cables must be calibrated per manufacturer's operation manual. The GPA representative shall:
  - 10.1.8.1. Verify the last time equipment was calibrated. This date should be in accordance with the operation manual.
  - 10.1.8.2. Verify how often (number of poles) the equipment requires calibration.
    - a. The person or company calibrating the equipment shall be a calibrator certified by the manufacturer. GPA shall obtain a copy of the certification from the supplier or contractor.
  - 10.1.8.3. Verify that the equipment tension setting stress is applicable to the structural design criteria requirements. At release of strands, 4,500-psi minimum stresses shall be maintained otherwise the pole is defective.
- 10.1.9. The GPA representative shall check the formwork placement and ensure that the steel mold for the concrete pole is correct for the application. Check the following:
  - 10.1.9.1. Type of pole (Class A or Class B).
  - 10.1.9.2. Pole length measured.
  - 10.1.9.3. Pole diameter measured bottom and top.
  - 10.1.9.4. Complete concrete pole checklist.
  - 10.1.9.5. Sleeve aligned to opposite sleeve and firmly attached to form.
  - 10.1.9.6. Mold is cleaned of debris.
- 10.2. **Placing of Reinforcement:**
  - 10.2.1. Steel reinforcement shall be fabricated as shown on the shop drawings and placed in position in the forms within the tolerances specified in ACI 318. Reinforcement shall be adequately secured so as to remain in the proper position during the placement of the concrete.
  - 10.2.2. Reinforcement shall have a minimum of 1.8 inch concrete cover on the exterior, and 0.75 inches on the interior.
  - 10.2.3. Reinforcement shall be free from loose scale.

EFFECTIVE DATE: 1/21/13	ISSUED: 	APPROVED: 
-------------------------	---	---



 <b>GUAM POWER AUTHORITY HAGATNA, GUAM</b>	<b>SPECIFICATION E-035</b>	Page 13 of 53
		January 15, 2013
		REV. 2
PREPARED BY THE ENGINEERING DEPARTMENT		

- 10.2.4. GPA shall be notified as soon as possible of any poles with less than ¼ inch of spun concrete inside cover within 3 feet of the pole tip. At GPA’s sole discretion, GPA may reject the pole or may allow the pole to be repaired by swabbing the interior with an epoxy liner (per ASTM C881 - Type V, Class B or C) and plugging with 3,000 psi concrete to GPA’s satisfaction to a distance of 42 inches from the tip. No pole shall be plugged or considered for acceptance by GPA unless assurance is made by the manufacturer that the repaired pole can meet all requirements of this specification.
- 10.2.5. Spiral reinforcement shall cover the entire pole length. The minimum clear spacing of spiral reinforcement in the top 2 feet and bottom 2 feet of the pole shall be 4/3 of the maximum coarse aggregate or three times the strand diameter, whichever is larger, but not less than one inch. The maximum clear spacing for the remainder of the pole shall not exceed 4 inches.
- 10.2.6. The longitudinal steel shall not be cut for any reason unless approved by GPA – GPA may reject any pole in which the longitudinal steel is cut. All exposed steel resulting from drilled holes shall be covered with an epoxy paste per ASTM C881 Type III. Areas with moderate or severe spalling shall be cleaned and reformed with an epoxy paste or epoxy concrete per ASTM C881 Type II. 10.3. Anchors, Inserts and Hole Formers: All anchors, inserts and hole formers shall be firmly positioned so as not to become displaced during the placing of concrete. They shall not be in contact or attached to the reinforcement. They shall be firmly attached to the forms.
- 10.2.7. All non-corrosive through-bolts and inserts provided by the manufacturer shall be of a noncorrosive material. Cadmium-plated and aluminum material shall not be used. All inserts shall be constructed of plastic PVC designed and manufactured for the intended purpose and used according to manufacturer's recommendations. If the manufacturer considers lifting devices necessary or desirable, suitable flush inserts may be cast into the pole with removable lifting attachments.
- 10.2.8. Where the sketches indicate holes for thru-bolts, these shall be made by using plastic held firmly in place and shall be full length of pole diameter for all through holes having internal diameters as required and shown in the Appendices. Unless otherwise noted on the drawings, holes shall be perpendicular to and pass through the centerline of the pole.
- 10.2.9. The use of porcelain or other ceramic type inserts is not permitted.
- 10.2.10. Inserts shall not fail before the pole reaches ultimate strength, unless permitted by GPA.
- 10.2.11. The pole manufacturer shall provide preformed inserts at two locations to allow air circulation within the pole. Inserts shall be 1 inch minimum diameter and shall have a louvered opening. The inserts shall be located within 10 feet of the tip and within 10 feet above the groundline.
- 10.2.12. Holes may not be drilled through the pole wall, except as specifically necessary to correct errors or omissions and only if approved by GPA.

EFFECTIVE DATE:	1/31/13	ISSUED:		APPROVED:	
-----------------	---------	---------	---	-----------	---

 <p>GUAM POWER AUTHORITY HAGATNA, GUAM</p>	<p><b>SPECIFICATION E-035</b></p>	Page 14 of 53
		January 15, 2013
		REV. 2
<p>PREPARED BY THE ENGINEERING DEPARTMENT</p>		

10.4. Prestressing: Measure the required elongation of the prestressing steel prior to and after transfer of the prestressing force. Verify and record the stress in the steel by measuring and recording the elongation of the steel and the jacking pressure reading on an approved calibrated gage. Provide means for measuring the elongation of the steel to the nearest 0.125 inch. If the difference between any of the results of the measurements and gage reading is more than five percent, correct the cause of the discrepancy prior to construction of additional poles and mark the affected pole for additional testing. Provide the tensioning steel with a uniform prestress prior to being brought to design prestress. Transfer the prestressing force when the concrete has attained 0.80 of the minimum ultimate compressive strength of the pole. Induce the same initial prestress in each unit when several units of prestressing in a pole are stretched simultaneously. A complete record of the stressing of the strands shall be submitted to GPA as part of the Pole Manufacturing Data.

10.4.1. Clear distance between prestressing steel strands shall be either 4/3 times the maximum aggregate size or 3 times the strand diameter, whichever is larger. In the event that this condition is not met at the pole tip, closer spacing would be permitted provided that the placement of concrete can be accomplished satisfactorily, adequate stress transfer can take place, and appropriate provisions are used for maintaining spacing between the prestressing steel strands.

Prestressing steel stress limits shall not exceed:

- a. 80 percent of the ultimate strength or 94 percent of the yield strength or the maximum value recommended by the manufacturer of prestressing steels or anchorages for jacking force;
- b. 74 percent of the ultimate strength or 82 percent of the yield strength immediately after prestress transfer; and
- c. 70 percent of the ultimate strength for post-tensioned steel at anchorages and couplers immediately after anchorage.

10.4.2. Strands shall be properly tensioned, secured and tied to spiral wire. At release of strands, 4,00-psi minimum stresses shall be maintained otherwise the pole is defective.

10.5. Consolidation of Concrete: All concrete shall be centrifugally spun in the forms. For external form vibration, forms must be of a design adequate to prevent distortion or failure. The poles shall be centrifugally spun using prestressed strands, rod, wire or with additional mild strength reinforcement.

10.6. Curing: Curing shall be accomplished in accordance with PCI MNL -116. The casting bed for concrete members cured by steam shall be enclosed completely with a suitable enclosure to minimize moistened heat losses. Curing methods shall be maintained until the specified strength of 4,500-psi minimum stress strength for detensioning has been reached.

10.6.1. Moist Curing: Moist cure for not less than 10 days. Proportionally increase the curing when the ambient air temperature falls below 50 degrees Fahrenheit.

10.6.2. Steam Curing: Include with the shop drawings methods and procedures for steam curing. Moist cure for not less than four hours prior to steam curing. During the application of steam, increase the air temperature at a rate not exceeding 40 degrees Fahrenheit per hour until the air temperature is maintained between 140 and 160

EFFECTIVE DATE: 1/21/13	ISSUED: 	APPROVED: 
-------------------------	---	---

 GUAM POWER AUTHORITY HAGATNA, GUAM PREPARED BY THE ENGINEERING DEPARTMENT	SPECIFICATION E-035	Page 15 of 53
		January 15, 2013
		REV. 2

degrees Fahrenheit until the concrete has reached the required strength; air temperature above 160 degrees Fahrenheit will not be permitted. In discontinuing the steam application, decrease the air temperature at a rate not exceeding 40 degrees Fahrenheit per hour until reaching a temperature of 20 degrees Fahrenheit above the temperature of the air to which the concrete will be exposed. Use a recording type thermometer for measuring temperature within the steam curing chambers.

10.6.3. Accelerated Curing: Other means of accelerated curing, where standard with the manufacturer, shall be subject to the temperature controls specified for steam curing. Moist cure for not less than four hours prior to other means of accelerated curing. Take precautions to prevent the concrete surface from drying out during the curing period.

10.7. Finishing

- 10.7.1. The surface of the pole shall have a smooth finish with no unsealed cracks. Cracks shall be sealed either by use of an epoxy injection system following the epoxy manufacturer's specifications, or by V-notching the crack on a 1:1 slope to a minimum depth of ¼ inch, then filling the V-notch with an epoxy seal per ASTM C881 Type IV. Covering the crack with an epoxy coating will not be allowed.
- 10.7.2. Small cavities caused by air bubbles, honeycomb spots, or other small voids, shall be cleaned thoroughly, saturated with water and then carefully pointed with a cement mortar. A small cavity is defined as one not larger than ½ inch in diameter or deeper than ¼ inch.
- 10.7.3. If any cavities or voids absorb water which indicate the void extends into wall of the pole, then the pole shall be rejected.
- 10.7.4. The manufacturer shall seal both ends of the pole and protect the steel stands from corrosion. The system used shall be approved by GPA.
- 10.7.5. The center void at the top end of the pole shall be sealed with a minimum 6 inch thick 1000 psi strength concrete plug and the pole tip capped. The pole tip cap shall be a suitable epoxy-aggregate mortar securely bonded to the pole, or shall be a metal or polymer cap securely held in place with set screws. Sharp edges shall be tooled to form smooth, chamfered corners. The manufacturer shall assure that the capping method will prevent weather intrusion into the pole and prevent pole tip deterioration.
- 10.7.6. The center void at the bottom end of the pole shall remain unsealed. The pole manufacturer shall meet the concrete cover requirements at the bottom end of the pole where the concrete plug is omitted. The concrete cover requirements are referenced in this specification. The pole must meet these requirements or the pole will be rejected.
- 10.7.7. Where application of epoxy-aggregate mortar is specified, the surface of the pole where the mortar is to be applied shall first be coated with the epoxy coating. This coating shall be allowed to cure to a tacky, but not hardened state, before the mortar is applied. After the mortar has been applied and allowed to cure for 24 hours, a top coat of epoxy coating, 5 mil thick, shall be applied over the mortar and the surrounding area of the pole.

EFFECTIVE DATE:	1/31/13	ISSUED:		APPROVED:	
-----------------	---------	---------	---	-----------	---

 <b>GUAM POWER AUTHORITY</b> <b>HAGATNA, GUAM</b>	<b>SPECIFICATION E-035</b>	Page 16 of 53
		January 15, 2013
		REV. 2
PREPARED BY THE ENGINEERING DEPARTMENT		

**11.0 POLE ACCEPTANCE TESTS:**

- 11.1. Prior to acceptance of the poles all required submittals and reports are to be approved and a strength test shall be performed on two poles selected by GPA.
- 11.2. The strength test method to be used is to place the pole horizontally in a test frame seven feet from the butt of its length held firmly into place. Using a dynamometer, a force equal to the specified ultimate load is applied at a point one foot from the top. Should the test pole fails any of the criteria at the cracking, deflection and breaking test loads, another pole shall be tested. Failure of the second pole will be the cause of rejection of the complete group. See Appendix B for details of the test apparatus.
- 11.3. During the application of the allowable cracking load there shall be no visible cracking.
- 11.4. The maximum deflection at the allowable load is to be calculated as  $L/12$ .
- 11.5. The breaking load for the pole is to be taken as the ultimate load/0.90
- 11.6. The Test Procedure for Testing Concrete Poles is provided in the Appendices. Details of all test procedures contained herein and methods of measuring and recording test loads and deflections shall be specified by the manufacturer and approved by GPA prior to manufacture.
- 11.7. Manufacturer shall provide Certificate of calibration for hydraulic jack and dynamometer from an ISO/IES 17025:1999 Accredited Laboratory.
- 11.8. Material procurement for test poles shall be identical to material procurement procedures for regular production run poles.
- 11.9. The number, location, direction, holding time, sequence, and increments of the test loads along with the number, location, and direction of deflection readings for an individual pole test shall be approved by GPA prior to pole testing.
- 11.10. The method of attaching the test loads to the pole, applying the test loads, measuring and recording the test loads, and measuring and recording the deflections shall be approved by GPA prior to pole testing.
- 11.11. A full report listing results shall be submitted to GPA after completion of all testing. Copies of mill test reports shall be included in the load test report. The report shall also include a complete description of the load tests with diagrams and photographs. If required, the manufacturer shall provide GPA with the following testing data:
  - a. Location of testing;
  - b. Method of full scale testing: upright or horizontal; and
  - c. The pole tester shall issue GPA three (3) copies of the Pole Test Report. This report shall include descriptions, tools, and drawings describing the above test.
- 11.12. Use of any factory tested poles to meet order requirements shall be determined by GPA.
- 11.13. Manufacturing and testing procedures shall be in compliance with applicable codes and standards listed in Section 2.0 in this specification.

EFFECTIVE DATE: 1/31/13	ISSUED: 	APPROVED: 
-------------------------	---	---

 GUAM POWER AUTHORITY HAGATNA, GUAM PREPARED BY THE ENGINEERING DEPARTMENT	<b>SPECIFICATION E-035</b>	Page 17 of 53
		January 15, 2013
		REV. 2

- 11.14. Upon request, the manufacturer shall furnish GPA with certified test reports for the steel and concrete used.
- 11.15. The manufacturer shall make adequate tests and inspections to determine that each of the poles furnished is in strict accordance with this specification. At the request of GPA, the manufacturer shall submit a quality assurance report to GPA prior to the shipment of each pole and shall include the following minimum information:
  - Fabrication number;
  - Minimum and maximum tip wall thicknesses and steel coverages (to inside and outside) measurements shall be made at 3 inches from the tip;
  - Minimum and maximum butt wall thicknesses and steel coverages (to inside and outside) measurements shall be made at 3 inches from butt;
  - Condition of pole interior and evidence of exposed rings or reinforcement steel;
  - Proper hole and insert locations and sizes;
  - Evidence of cracking during or after two-point handling.
  - Actual manufactured pole weight;
  - Report of any repairs made to the pole;
  - Date of manufacture and inspection(s); and
  - Inspector's seal.
- 11.16. All material and workmanship shall be subject to inspection, examination, and test for conformance to the requirements of this specification by GPA. The inspection, examination, or testing could be done at any time during material procurement, manufacturing, storage periods, transit, or at the pole destination. Inspection, examinations, and tests may be waived by GPA, but in no case shall this be interpreted as releasing the manufacturer from the manufacturer's responsibilities for delivering poles that meet the requirements of this specification.
- 11.17. The manufacturer shall furnish certified test reports to GPA, upon request, showing the results of all of the tests required by this specification and applicable reference specifications.
- 11.18. Tests shall be in accordance with all applicable standard specifications and codes.
- 11.19. Failure of the manufacturer to comply with these specifications will be sufficient reason for rejection of any or all poles which do not comply with these specifications.

**12.0 BIRTHMARK:**

- 12.1. Each pole shall bear indented markings located 5 feet above the ground hole and in line with the center of gravity mark and ground hole. This birthmark shall include the following:
  - Supplier's identity mark
  - Month and year of manufacture
  - Pole height
  - Pole class

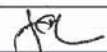
EFFECTIVE DATE: 1/21/13	ISSUED: 	APPROVED: 
-------------------------	---	---

 GUAM POWER AUTHORITY HAGATNA, GUAM PREPARED BY THE ENGINEERING DEPARTMENT	SPECIFICATION E-035	Page 18 of 53
		January 15, 2013
		REV. 2

- Batch or lot number identification
- Pole index number:

SSOP1127 - 55 FT. Class A Pole  
 SSOP1128 - 55 FT. Class B Pole  
 SSOP1105 - 45 FT. Class A Pole  
 SSOP1106 - 45 FT. Class B Pole  
 SSOP 1103 - 35 FT. Pole

- 12.2. Supplier shall also provide a mark indicating the longitudinal center of gravity of each pole and a lifting mark for erection.
- 12.3. Substitution of stencilling or similar method of marking for indented birthmarks is not acceptable and shall be the cause for rejection. Suppliers should obtain GPA approval of their marking method.
- 12.4. The birthmark shall be a 2 inches diameter white porcelain tile by ¼ inch thick with blue lettering, embedded in the pole and flush with exterior surface.
- 12.5. The center of gravity mark shall be a ¾ inch diameter red porcelain tile by ¼ inch thick embedded in the pole and flush with exterior surface.

**13.0 SHIPPING AND DELIVERY REQUIREMENTS:**

The Supplier shall have sufficient instructions for handling, storage, shipping and delivery to prevent against injury or damage to the poles. Poles shall be securely blocked in position to prevent shifting during shipment and delivery.

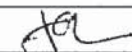
EFFECTIVE DATE: 1/31/13	ISSUED: 	APPROVED: 
-------------------------	---	---

 <p><b>GUAM POWER AUTHORITY</b> HAGATNA, GUAM</p> <p>PREPARED BY THE ENGINEERING DEPARTMENT</p>	<p><b>SPECIFICATION E-035</b></p>	Page 19 of 53
		January 15, 2013
		REV. 2

APPENDIX A1-A 45 FOOT CLASS A CONCRETE POLE (SELF SUPPORTING)

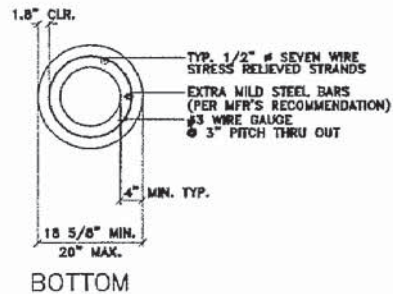
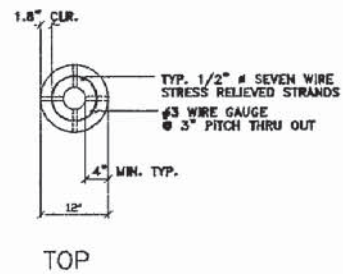
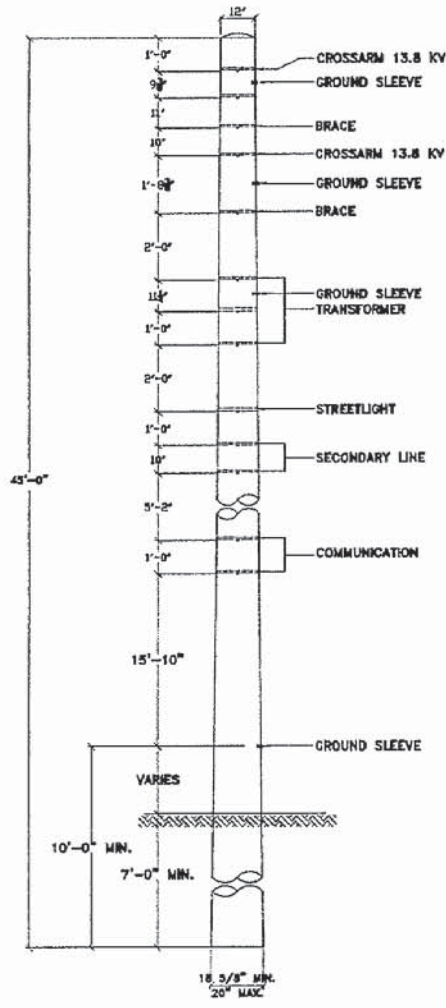

NOTE:

- GROUND SLEEVE SHALL BE IN THE MIDDLE BETWEEN HOLES UNLESS SHOWN OTHERWISE.
- ALL HOLES SHALL BE 1 1/16" DIAMETER.
- POLE TOP & BUTT DIAMETERS NOT TO EXCEED 12 & 20 INCHES RESPECTIVELY.

45 FOOT CONCRETE POLE  
(CLASS A SELF-SUPPORTING)

EFFECTIVE DATE: 1/21/13	ISSUED: [Signature]	APPROVED: [Signature]
-------------------------	---------------------	-----------------------

 <b>GUAM POWER AUTHORITY</b> <b>HAGATNA, GUAM</b> PREPARED BY THE ENGINEERING DEPARTMENT	<b>SPECIFICATION E-035</b>	Page 20 of 53
		January 15, 2013
		REV. 2

APPENDIX A1-B 55 FOOT CLASS A CONCRETE POLE (SELF SUPPORTING)

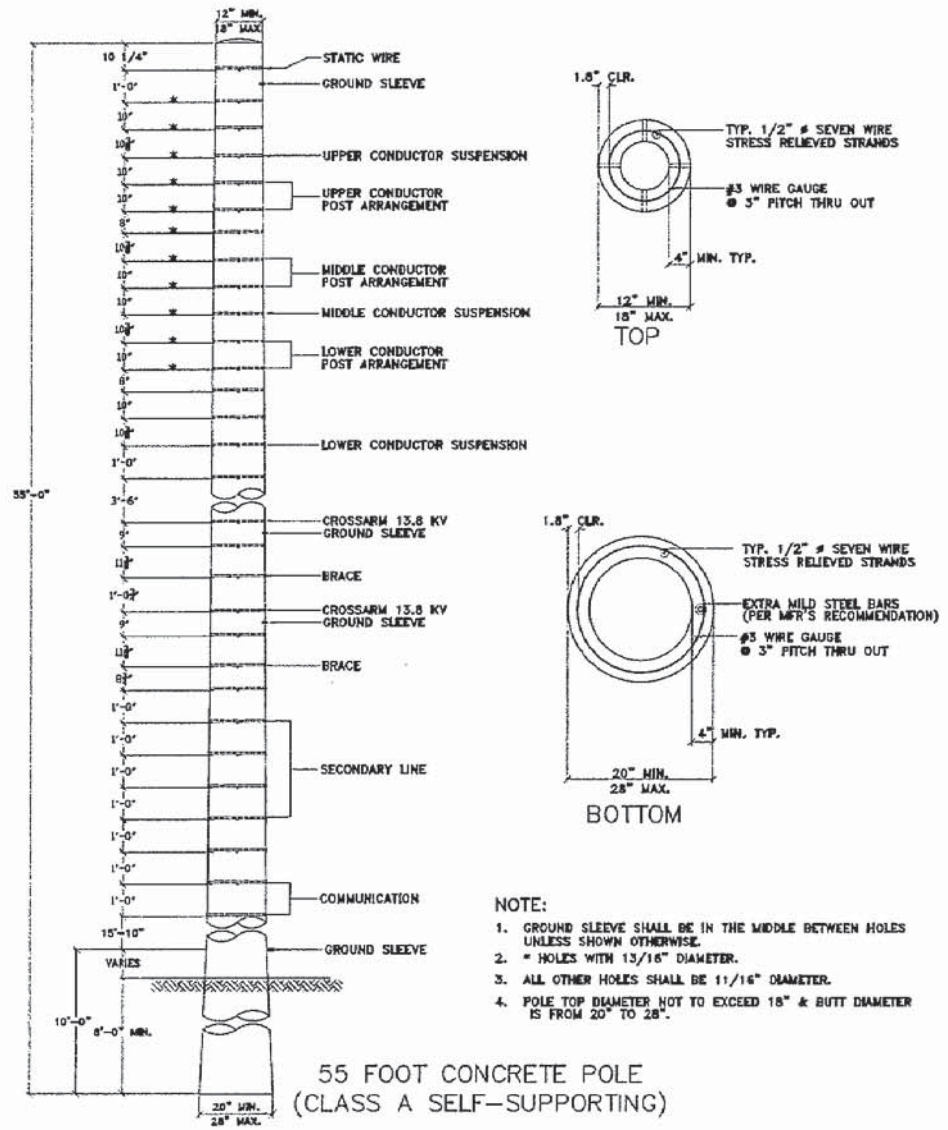



EFFECTIVE DATE: 1/31/10	ISSUED: [Signature]	APPROVED: [Signature]
-------------------------	---------------------	-----------------------

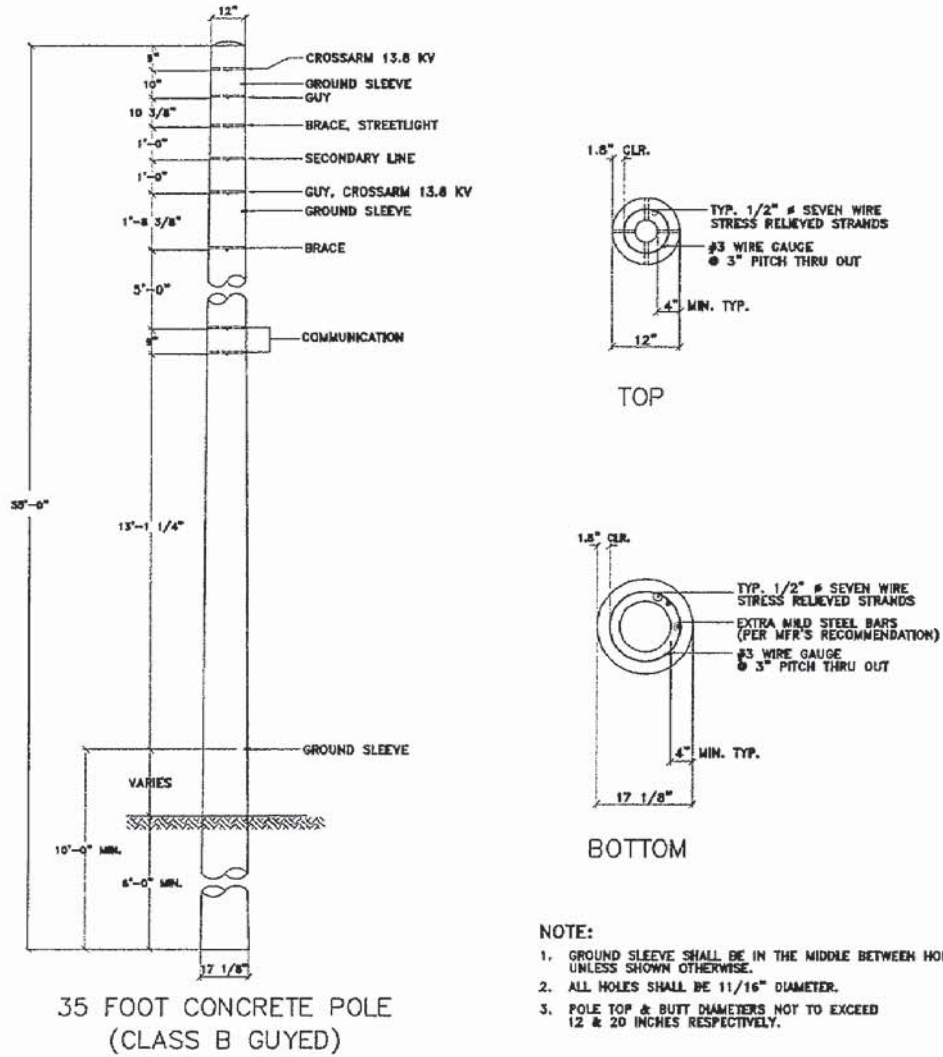

 <p>GUAM POWER AUTHORITY HAGATNA, GUAM</p>	<p><b>SPECIFICATION E-035</b></p>	Page 21 of 53
		January 15, 2013
PREPARED BY THE ENGINEERING DEPARTMENT		REV. 2

APPENDIX A2-A 35 FOOT CLASS B CONCRETE POLE (GUYED)

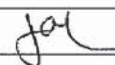

EFFECTIVE DATE:	1/31/13	ISSUED:		APPROVED:	
-----------------	---------	---------	---	-----------	---

 <p>GUAM POWER AUTHORITY HAGATNA, GUAM</p> <p>PREPARED BY THE ENGINEERING DEPARTMENT</p>	<p><b>SPECIFICATION E-035</b></p>	Page 22 of 53
		January 15, 2013
		REV. 2

APPENDIX A2-B 45 FOOT CLASS B CONCRETE POLE (GUYED)

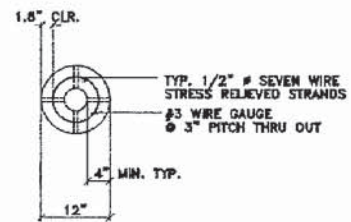
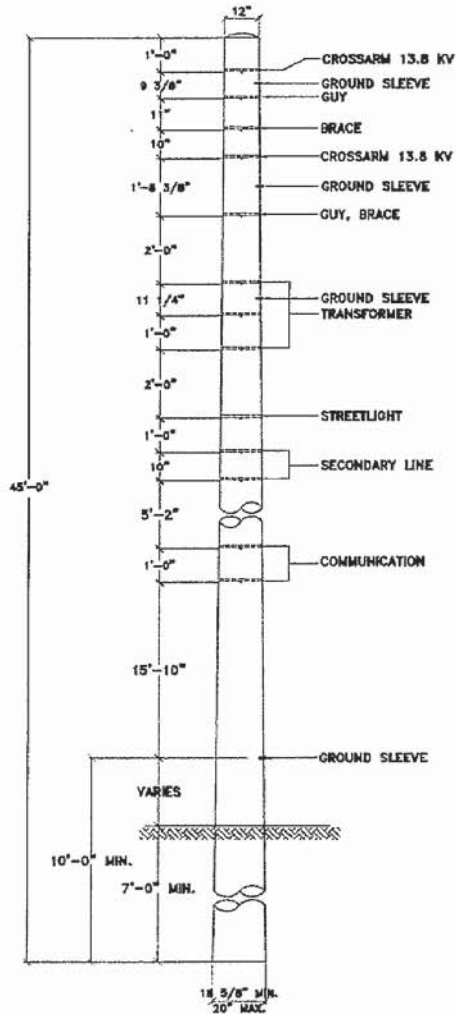

TOP

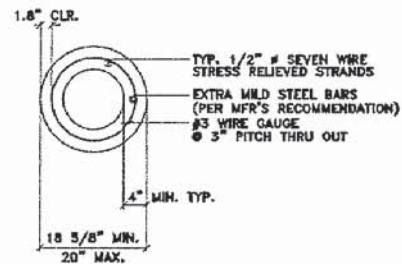

BOTTOM

NOTE:

1. GROUND SLEEVE SHALL BE IN THE MIDDLE BETWEEN HOLES UNLESS SHOWN OTHERWISE.
2. ALL HOLES SHALL BE 11/16" DIAMETER.
3. POLE TOP & BUTT DIAMETERS NOT TO EXCEED 12 & 20 INCHES RESPECTIVELY.

45 FOOT CONCRETE POLE  
(CLASS B GUYED)

EFFECTIVE DATE: 1/31/13	ISSUED: 	APPROVED: 
-------------------------	---	---

 <p>GUAM POWER AUTHORITY HAGATNA, GUAM</p> <p>PREPARED BY THE ENGINEERING DEPARTMENT</p>	<p><b>SPECIFICATION E-035</b></p>	Page 23 of 53
		January 15, 2013
		REV. 2

APPENDIX A2-C 55 FOOT CLASS B CONCRETE POLE (GUYED)

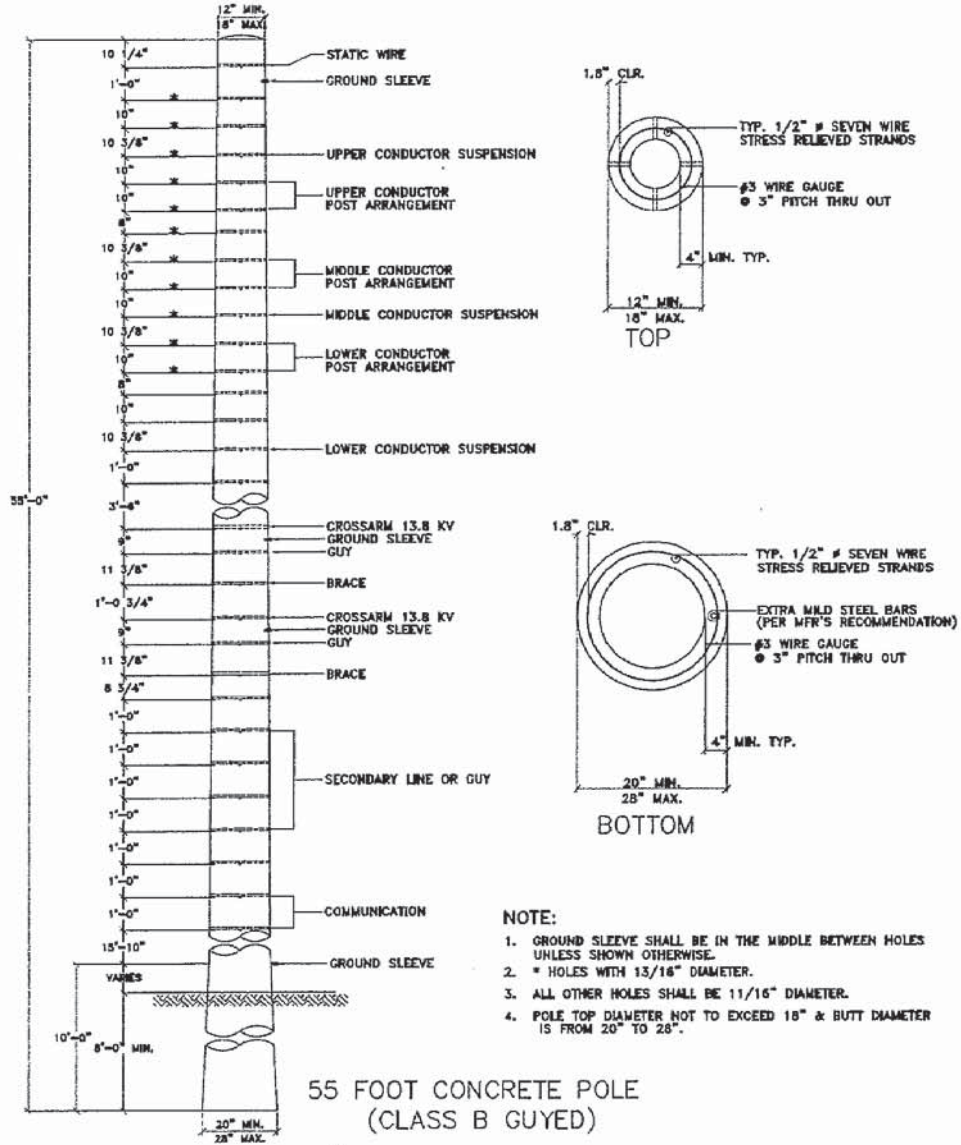

EFFECTIVE DATE:	1/31/13	ISSUED:		APPROVED:	
-----------------	---------	---------	---	-----------	---

 GUAM POWER AUTHORITY HAGATNA, GUAM PREPARED BY THE ENGINEERING DEPARTMENT	SPECIFICATION E-035	Page 24 of 53
		January 15, 2013
		REV. 2

APPENDIX A3 DESIGN CRITERIA

Permissible stresses in concrete

Stresses in concrete (after allowance for all pre-stress losses) shall not exceed the following:

- (a) Extreme fiber stress in compression due to pre-stress plus sustained load..... 0.45 f'c psi  
 Extreme fiber stress in compression due to pre-stress plus total load..... 0.60 f'c psi
- (b) Extreme fiber stress in tension ..... 7.5√(f'c) psi

Permissible stresses in pre-stressing tendons

Tensile stress in pre-stressing tendons shall not exceed the following:

- (a) Due to tendon jacking force ..... 0.94 fpy  
 but not greater than 0.85 fpu or maximum value  
 recommended by manufacturer of (pre-stressing) tendons.
- (b) Immediately after pre-stress transfer ..... 0.82 fpy  
 but not greater than 0.74 fpu.

Loss of pre-stress

To determine the effective pre-stress (fse) allowance, the following sources of loss of pre-stress shall be considered:

- (a) Elastic shortening of concrete
- (b) Creep of concrete
- (c) Shrinkage of concrete
- (d) Relaxation of tendon stress

Computation of losses

The following shall be used for computation of pre-stress losses for pre-tensioned bonded tendons:

Elastic Shortening of Concrete (ES)

$$ES = E_s \frac{f_{ci} r}{E_{ci}}$$

Creep of Concrete (CR)

$$CR = 2 \frac{E_s}{E_c} (f_{cr} - f_{cus})$$

Shrinkage of Concrete (SH)

$$SH = 8.2 \times 10^{-6} E_s (1 - 0.06 V/S) (100 - RH)$$

Relaxation of Tendon Stress (RE)

$$RE = [K_{re} - J (SH + CR + ES)] C$$

In which the values of K<sub>re</sub>, J and C are taken from Tables 2 and 3.

EFFECTIVE DATE: 1/31/13	ISSUED: 	APPROVED: 
-------------------------	---	---

 GUAM POWER AUTHORITY HAGATNA, GUAM PREPARED BY THE ENGINEERING DEPARTMENT	SPECIFICATION E-035	Page 25 of 53
		January 15, 2013
		REV. 2

TABLE 2- Values of  $K_{re}$  and  $J$

Type of Tendon	$K_{re}$	$J$
270 Grade stress-relieved strand or wire	20,000	0.150
250 Grade stress-relieved strand or wire	18,500	0.140
240 or 235 Grade stress-relieved wire	17,600	0.130
270 Grade low-relaxation strand	5,000	0.040
250 Grade low-relaxation wire	4,630	0.037
240 or 235 Grade low-relaxation wire	4,400	0.035
145 or 160 Grade stress-relieved bar	6,000	0.050

TABLE 3 Values of C

$f_{pi} / f_{pu}$	Stress relieved strand or wire	Stress relieved bar or relaxation strand or wire
0.80		1.28
0.79		1.22
0.78		1.16
0.77		1.11
0.76		1.05
0.75	1.45	1.00
0.74	1.36	0.95
0.73	1.27	0.90
0.72	1.18	0.85
0.71	1.09	0.75
0.70	1.00	0.70
0.69	0.94	0.66
0.65	0.89	0.61
0.64	0.68	0.49
0.63	0.63	0.45
0.62	0.58	0.41
0.61	0.53	0.37
0.60	0.49	0.33

Maximum Loss

The total amount of pre-stress loss (psi) due to elastic shortening, creep, shrinkage, and relaxation need not be more than the values given below if the tendon stress immediately after anchoring does not exceed  $0.83f_{py}$ :

Type of Strand

Stress relieved strand 45,000

EFFECTIVE DATE: 1/31/10	ISSUED: 	APPROVED: 
-------------------------	---	---

 GUAM POWER AUTHORITY HAGATNA, GUAM	SPECIFICATION E-035	Page 26 of 53
		January 15, 2013
		REV. 2
PREPARED BY THE ENGINEERING DEPARTMENT		

Low-relaxation strand 40,000 (for normal concrete)

Refer to Appendix D; Basic Design Criteria, for applicable codes, references, material stresses and loading requirements.

EFFECTIVE DATE: 1/31/10	ISSUED: 	APPROVED: 
-------------------------	---	---

 <p>GUAM POWER AUTHORITY HAGATNA, GUAM</p> <p>PREPARED BY THE ENGINEERING DEPARTMENT</p>	<p>SPECIFICATION E-035</p>	Page 27 of 53
		January 15, 2013
		REV. 2

APPENDIX A4-A CLASS A LOADING SET-UP

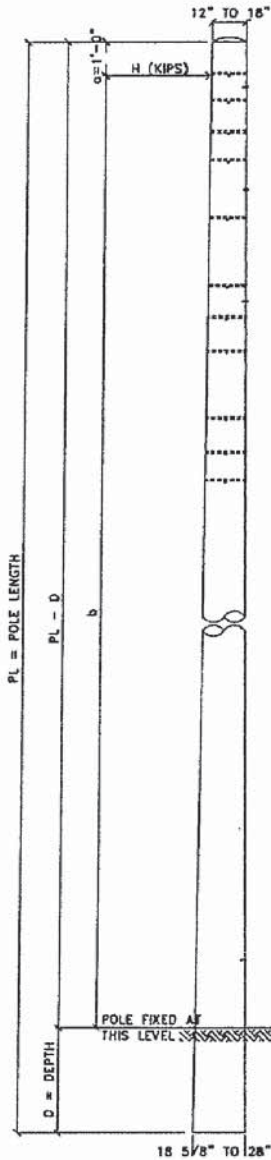

CLASS "A" POLES  
(SELF-SUPPORTING POLES)

LOADING CONDITIONS:

- 1)  $0.75 (1.7 H + 1.7 HL (w))$
- 2)  $0.75 (1.7 H + 1.87 HL (s))$

WHERE: HL(s) IS HORIZONTAL LOAD DUE TO SEISMIC FORCES.  
THE SEISMIC LOADING IS DISTRIBUTED ALONG THE POLE  
ACCORDING TO  $HL(s) = 0.34 (Weight)$

HL(w) IS HORIZONTAL LOAD ON POLE DUE TO A UNIFORM  
PRESSURE OF 61.5 psf x HEIGHT CORRECTION FACTOR  
FOR THE POLE, CONDUCTORS AND APPURTENANCES.

MOMENTS DERIVED FROM THE ABOVE LOADING SHALL BE LESS  
THAN OR EQUAL TO 0.9 x ULTIMATE MOMENT CAPACITY OF THE  
SECTION BEING ANALYZED:

MOMENT  $\leq 0.9 \times$  ULTIMATE MOMENT CAPACITY

THE ULTIMATE MOMENT CAPACITY IS TO BE CALCULATED IN  
ACCORDANCE WITH THE CURRENT EDITION OF ACI 318.  
CRACKING MOMENT SHALL BE EQUAL TO ONE-HALF OF  
THE ULTIMATE MOMENT CAPACITY OF THE POLE.

POLE HEIGHT	DEPTH D
45'-0"	7'-0"
55'-0"	8'-0"

EFFECTIVE DATE: 1/31/13	ISSUED: [Signature]	APPROVED: [Signature]
-------------------------	---------------------	-----------------------

 GUAM POWER AUTHORITY HAGATNA, GUAM PREPARED BY THE ENGINEERING DEPARTMENT	<b>SPECIFICATION E-035</b>	Page 28 of 53
		January 15, 2013
		REV. 2

APPENDIX A4-B 45 FOOT CLASS A DESIGN DATA

45' CLASS A – SELF-SUPPORTING POLES  
 MUST SATISFY STRENGTH DESIGN AS FOLLOWS:

HORIZONTAL DEFLECTION ANGLE ( $\theta$ )	HORIZONTAL LOADS @ 1' BELOW TOP		MOMENT @ GROUND LEVEL	
	WORKING STRESS (KIPS)	ULTIMATE STRENGTH (KIPS)	WORKING STRESS (FT-KIPS)	ULTIMATE STRENGTH (FT-KIPS)
5°	5.63	7.18	208.38	265.68
10°	5.79	7.38	214.11	272.99
15°	5.93	7.56	219.51	279.88
20°	6.07	7.74	224.56	286.31
25°	6.19	7.90	229.19	292.22
30°	6.31	8.04	233.38	297.56
35°	6.41	8.17	237.07	302.27
40°	6.49	8.28	240.25	306.31
45°	6.56	8.37	242.86	309.65
50°	6.62	8.44	244.89	312.23
55°	6.66	8.49	246.30	314.03
60°	6.68	8.51	247.07	315.01
65°	6.68	8.52	247.17	315.14
70°	6.67	8.50	246.60	314.42
75°	6.63	8.45	245.34	312.81
80°	6.58	8.39	243.39	310.32
85°	6.51	8.30	240.73	306.93
90°	6.42	8.18	237.37	302.65

NOTE: ABOVE VALUES ARE BASED ON 200 FEET POLE SPACING.

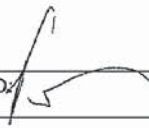
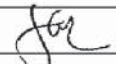
EFFECTIVE DATE: 1/31/13	ISSUED: 	APPROVED: 
-------------------------	---	---



 GUAM POWER AUTHORITY HAGATNA, GUAM PREPARED BY THE ENGINEERING DEPARTMENT	<b>SPECIFICATION E-035</b>	Page 29 of 53
		January 15, 2013
		REV. 2

APPENDIX A4-C 55 FOOT CLASS A DESIGN DATA

55' CLASS A – SELF-SUPPORTING POLES  
 MUST SATISFY STRENGTH DESIGN AS FOLLOWS:

HORIZONTAL DEFLECTION ANGLE (Θ)	HORIZONTAL LOADS @ 1' BELOW TOP		MOMENT @ GROUND LEVEL	
	WORKING STRESS (KIPS)	ULTIMATE STRENGTH (KIPS)	WORKING STRESS (FT-KIPS)	ULTIMATE STRENGTH (FT-KIPS)
5°	9.79	12.48	450.16	573.95
10°	10.33	13.17	475.09	605.73
15°	10.85	13.83	499.03	636.26
20°	11.34	14.46	521.79	665.28
25°	11.81	15.06	543.19	692.57
30°	12.24	15.61	563.05	717.89
35°	12.64	16.11	581.20	741.04
40°	12.99	16.56	597.49	761.80
45°	13.30	16.96	611.75	779.98
50°	13.56	17.29	623.86	795.42
55°	13.78	17.56	633.69	807.96
60°	13.94	17.77	641.14	817.45
65°	14.05	17.91	646.10	823.78
70°	14.10	17.98	648.50	826.84
75°	14.09	17.97	648.28	826.56
80°	14.03	17.89	645.40	822.89
85°	13.91	17.73	639.82	815.78
90°	13.73	17.51	631.55	805.22

NOTE: ABOVE VALUES ARE BASED ON 200 FEET POLE SPACING.

EFFECTIVE DATE: 1/31/13	ISSUED: [Signature]	APPROVED: [Signature]
-------------------------	---------------------	-----------------------

 <p>GUAM POWER AUTHORITY HAGATNA, GUAM</p> <p>PREPARED BY THE ENGINEERING DEPARTMENT</p>	<p>SPECIFICATION E-035</p>	Page 30 of 53
		January 15, 2013
		REV. 2

APPENDIX A4-D CLASS B LOADING SET-UP

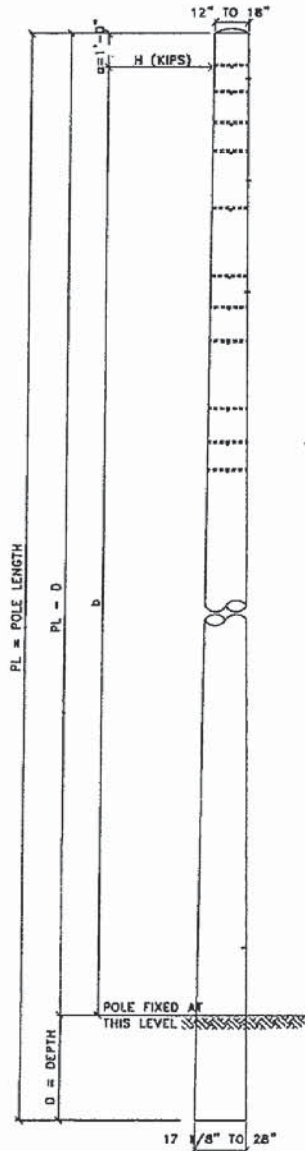

CLASS "B" POLES  
(GUYED POLES)

LOADING CONDITIONS:

- 1)  $0.75 (1.7 H + 1.7 HL (w))$
- 2)  $0.75 (1.7 H + 1.87 HL (s))$

WHERE: HL(w) IS HORIZONTAL LOAD ON POLE DUE TO A UNIFORM PRESSURE OF 61.5 psf x HEIGHT CORRECTION FACTOR FOR POLE, CONDUCTORS AND APPURTENANCES.

HL(s) IS HORIZONTAL LOAD DUE TO SEISMIC FORCES. THE SEISMIC LOADING IS DISTRIBUTED ALONG THE POLE ACCORDING TO  $HL(s) = 0.34 (Weight)$

MOMENTS DERIVED FROM THE ABOVE LOADING SHALL BE LESS THAN OR EQUAL TO 0.9 x ULTIMATE MOMENT CAPACITY OF THE SECTION BEING ANALYZED:



$MOMENT \leq 0.9 \times ULTIMATE \text{ MOMENT CAPACITY}$

THE ULTIMATE MOMENT CAPACITY IS TO BE CALCULATED IN ACCORDANCE WITH THE CURRENT EDITION OF ACI 318 CRACKING MOMENT SHALL BE EQUAL TO ONE-HALF OF THE ULTIMATE MOMENT CAPACITY OF THE POLE.

POLE HEIGHT	DEPTH D
35'-0"	6'-0"
45'-0"	7'-0"
55'-0"	8'-0"

EFFECTIVE DATE: 1/31/13	ISSUED: 	APPROVED: 
-------------------------	---	---

 GUAM POWER AUTHORITY HAGATNA, GUAM PREPARED BY THE ENGINEERING DEPARTMENT	<b>SPECIFICATION E-035</b>	Page 31 of 53
		January 15, 2013
		REV. 2

EFFECTIVE DATE: 1/31/13	ISSUED: 	APPROVED: 
-------------------------	---	---

 <b>GUAM POWER AUTHORITY</b> <b>HAGATNA, GUAM</b> PREPARED BY THE ENGINEERING DEPARTMENT	<b>SPECIFICATION E-035</b>	Page 32 of 53
		January 15, 2013
		REV. 2

APPENDIX A4-E 35 FOOT and 45 FOOT CLASS B DESIGN DATA

35' CLASS B – GUYED POLES  
 MUST SATISFY STRENGTH DESIGN AS FOLLOWS:

HORIZONTAL DEFLECTION ANGLE (Θ)	HORIZONTAL LOADS @ 1' BELOW TOP		MOMENT @ GROUND LEVEL	
	WORKING STRESS (KIPS)	ULTIMATE STRENGTH (KIPS)	WORKING STRESS (FT-KIPS)	ULTIMATE STRENGTH (FT-KIPS)
5°	4.52	5.76	126.56	161.37
10°	4.51	5.75	126.31	161.04
15°	4.50	5.73	125.88	160.50
20°	4.47	5.70	125.29	159.74
25°	4.45	5.67	124.52	158.77
30°	4.41	5.63	123.59	157.58
35°	4.37	5.58	122.50	156.18
40°	4.33	5.52	121.24	154.58
45°	4.28	5.46	119.82	152.77
50°	4.22	5.38	118.25	150.76
55°	4.16	5.31	116.52	148.56
60°	4.09	5.22	114.63	146.16
65°	4.02	5.13	112.60	143.57
70°	3.94	5.03	110.43	140.80
75°	3.86	4.92	108.12	137.85
80°	3.77	4.81	105.67	134.73
85°	3.68	4.69	103.09	131.44
90°	3.59	4.57	100.38	127.99

NOTE: ABOVE VALUES ARE BASED ON 200 FEET POLE SPACING.



EFFECTIVE DATE: 1/31/13	ISSUED: 	APPROVED: 
-------------------------	---	---

 GUAM POWER AUTHORITY HAGATNA, GUAM PREPARED BY THE ENGINEERING DEPARTMENT	<b>SPECIFICATION E-035</b>	Page 33 of 53
		January 15, 2013
		REV. 2

45' CLASS B – GUYED POLES  
 MUST SATISFY STRENGTH DESIGN AS FOLLOWS:

HORIZONTAL DEFLECTION ANGLE (Θ)	HORIZONTAL LOADS @ 1' BELOW TOP		MOMENT @ GROUND LEVEL	
	WORKING STRESS (KIPS)	ULTIMATE STRENGTH (KIPS)	WORKING STRESS (FT-KIPS)	ULTIMATE STRENGTH (FT-KIPS)
5°	5.34	6.80	197.41	251.70
10°	5.33	6.79	197.07	251.26
15°	5.31	6.77	196.50	250.54
20°	5.29	6.75	195.70	249.52
25°	5.26	6.71	194.68	248.22
30°	5.23	6.67	193.43	246.63
35°	5.19	6.62	191.97	244.76
40°	5.14	6.56	190.28	242.61
45°	5.09	6.49	188.38	240.18
50°	5.03	6.42	186.27	237.49
55°	4.97	6.34	183.95	234.54
60°	4.90	6.25	181.43	231.32
65°	4.83	6.16	178.71	227.85
70°	4.75	6.06	175.80	224.14
75°	4.67	5.95	172.70	220.19
80°	4.58	5.84	169.41	216.00
85°	4.49	5.72	165.96	211.60
90°	4.39	5.60	162.33	206.98

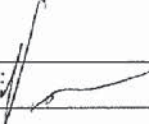
NOTE: ABOVE VALUES ARE BASED ON 200 FEET POLE SPACING.

EFFECTIVE DATE: 1/21/13	ISSUED: 	APPROVED: 
-------------------------	---	---



 <b>GUAM POWER AUTHORITY</b> <b>HAGATNA, GUAM</b> PREPARED BY THE ENGINEERING DEPARTMENT	<b>SPECIFICATION E-035</b>	Page 34 of 53
		January 15, 2013
		REV. 2

APPENDIX A4-F 55 FOOT CLASS B DESIGN DATA

55' CLASS B – GUYED POLES  
 MUST SATISFY STRENGTH DESIGN AS FOLLOWS:

HORIZONTAL DEFLECTION ANGLE (Θ)	HORIZONTAL LOADS @ 1' BELOW TOP		MOMENT @ GROUND LEVEL	
	WORKING STRESS (KIPS)	ULTIMATE STRENGTH (KIPS)	WORKING STRESS (FT-KIPS)	ULTIMATE STRENGTH (FT-KIPS)
5°	9.14	11.65	420.22	535.78
10°	9.12	11.62	419.33	534.64
15°	9.08	11.58	417.85	532.76
20°	9.04	11.52	415.78	530.11
25°	8.98	11.45	413.12	526.73
30°	8.91	11.36	409.89	522.60
35°	8.83	11.26	406.08	517.75
40°	8.73	11.13	401.70	512.17
45°	8.63	11.00	396.77	505.88
50°	8.51	10.85	391.29	498.89
55°	8.38	10.68	385.27	491.21
60°	8.23	10.50	378.72	482.87
65°	8.08	10.30	371.66	473.86
70°	7.92	10.09	364.10	464.22
75°	7.74	9.87	356.05	453.96
80°	7.56	9.63	347.53	443.10
85°	7.36	9.38	338.55	431.65
90°	7.16	9.12	329.14	419.65

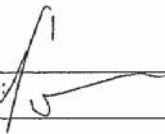
NOTE: ABOVE VALUES ARE BASED ON 200 FEET POLE SPACING.

EFFECTIVE DATE: 1/31/13	ISSUED: 	APPROVED: 
-------------------------	---	---

 <b>GUAM POWER AUTHORITY</b> <b>HAGATNA, GUAM</b>	<b>SPECIFICATION E-035</b>	Page 35 of 53
		January 15, 2013
		REV. 2
PREPARED BY THE ENGINEERING DEPARTMENT		

## APPENDIX A5 SUMMARY OF ABBREVIATIONS ,NOTATIONS AND DEFINITIONS

SUMMARY OF ABBREVIATIONS AND NOTATIONS



CR	=	stress loss due to creep of concrete
$E_{ci}$	=	modulus of elasticity of concrete at time pre-stress is applied
$E_c$	=	modulus of elasticity of concrete at time pre-stress is applied
$E_s$	=	modulus of elasticity of pre-stressing tendons. Usually 28,000 psi
ES	=	stress loss due to elastic shortening of concrete
$f_{cds}$	=	stress in concrete at center of gravity of tendons due to service loads
$f_{cir}$	=	net compressive stress in concrete at center of gravity of tendons immediately after the pre-stress has been applied to the concrete
$f_{pu}$	=	specified tensile strength of pre-stressing tendon, psi
RE	=	stress loss due to relaxation of tendons
RH	=	average ambient relative humidity
SH	=	stress loss due to shrinkage of concrete
V/S	=	volume to surface ratio. Usually taken as gross cross-sectional area of concrete member divided by its perimeter
$f'_c$	=	specified compressive strength of concrete, psi
$f_{py}$	=	specified yield strength of pre-stressing tendons, psi
$f_y$	=	specific yield strength of reinforcing bars, psi
E.W.	=	each way
H	=	horizontal load in kips
HL(s)	=	horizontal load in kips due to seismic forces
HL(w)	=	horizontal load in kips due to wind forces
$K_{re}$	=	coefficient
J	=	coefficient
C	=	coefficient
PL	=	pole length

EFFECTIVE DATE:	ISSUED: 	APPROVED: 
-----------------	---	---

 <b>GUAM POWER AUTHORITY</b> HAGATNA, GUAM PREPARED BY THE ENGINEERING DEPARTMENT	<b>SPECIFICATION E-035</b>	Page 36 of 53
		January 15, 2013
		REV. 2

DEFINITIONS

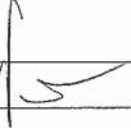
- Admixture - Any material other than water, aggregate, or cement that is used as an ingredient of concrete and added to concrete before or during its mixing to modify its properties.
- Appurtenance - Any hardware or structural members that are attached to the concrete pole to make a complete structure.
- Bonding, electrical - The electrical interconnecting of conductive parts, designed to maintain a common electrical potential.
- Cant hole - A through hole in the pole which is used in rotating the pole about its axis during setting. The hole is typically 1-1/2" in diameter and located approximately 4 feet above the groundline.
- Circumferential cracks - Cracks that parallel a cross-section of a concrete pole.
- Cracking moment - The moment which is developed in the pole at the time the cracking strength of the pole is experienced.
- Cracking strength - The point at which the concrete just begins to separate due to exceeding the tensile strength of the concrete on the tension face of the pole.
- Deadend structure - A type of guyed or unguyed structure on which the conductors are connected by strain insulators, with the usual purpose of terminating the conductor tension.
- Deleterious substance - Any substance that is not desirable in a mixture, usually causing harm in sufficient quantities.
- Dropout, steel cable - The terminating point of any longitudinal steel that is not continuous for the length of the pole.
- Efflorescence - The formation of a white film on the surface of the pole, typically caused by the emergence of chlorides during curing.
- Embedment - That portion of the pole which is designed to be located in the ground or other supporting medium.
- Factored load - See Ultimate Load.
- Foundation deflection - The magnitude and direction of displacement of the embedded portion of the pole or supporting foundation which is expected to occur with the response of the soil or supporting medium to the applied loading conditions. It is usually expressed in inches from the plumb position at the groundline or point below the groundline where supporting soil begins.
- Foundation rotation - The degree and direction of rotation of the embedded portion of the pole or supporting foundation about the groundline or point of fixity, if specified, which is expected to occur with the response of the soil or supporting medium to the applied loading conditions.
- Groundline - The point at which the embedment begins. Groundline is used for transmission line design such as determining ground clearances. Resistance from the supporting soils or other medium begins at or below groundline.
- Group of bolt holes - All of the holes in which a single hardware assembly will be attached.
- Guyed structure - A structure in which cable supports are used to increase its lateral load resistance.
- In-line face - The face of the pole which "faces" an adjacent structure in the line.

EFFECTIVE DATE: 1/31/13	ISSUED: 	APPROVED: 
-------------------------	---	---



 <b>GUAM POWER AUTHORITY</b> HAGATNA, GUAM	<b>SPECIFICATION E-035</b>	Page 37 of 53
		January 15, 2013
		REV. 2
PREPARED BY THE ENGINEERING DEPARTMENT		

- Load cycle** - The point at which a structure has undergone the range of loadings that are expected to occur over the life of the structure.
- Load case** - A group of loadings, restraints, (foundation deflections and foundation rotations) which are simultaneously applied to the structure at a particular point in time. Additional structural performance requirements may also be included.
- Load factor** - A multiplier which is applied to each of the vertical, transverse, and longitudinal structure loadings to obtain an ultimate factored load. The multiplier takes into account the variability of climatic events as well as the importance of the structure.
- Longitudinal cracks** - Cracks in concrete that parallel to the long axis of the pole.
- Longitudinal reinforcement** - The reinforcing steel which is installed along the long axis of the pole.
- Manufacturer** - The company responsible for the fabrication of the poles. The manufacturer makes the poles based on the design drawings developed by the structural designer, which is the engineer responsible for the structural design of the poles and is usually employed by the manufacturer.
- Modulus of elasticity** - The slope of the stress-strain diagram within the proportional range of an elastic material.
- P-delta (P- $\Delta$ ) moment** - The secondary moment created by vertical loads acting on the structure which deflects from its unloaded position.
- Pole end squareness** - A measure of how perpendicular the finished surface of the pole butt is to the longitudinal axis of the pole.
- Point of fixity** - The point on the pole at or below groundline where the maximum moment occurs. Location of this point is dependent on the characteristics of soils around the embedded portion of the pole.
- Pole failure** - The point at which the maximum strength of the pole is realized. Failure usually occurs with crushing of the concrete or permanent deformation.
- Pole sweep** - The measure of deviation from straightness along the length of the pole.
- Post-tensioned steel strand** - The longitudinal reinforcement that has been tensioned after the concrete has hardened.
- Prestressed concrete** - Reinforced concrete in which internal stresses have been introduced to reduce potential tensile stress in concrete resulting from loads.
- Pretensioned steel strand** - The longitudinal reinforcement that has been tensioned before concrete is placed. Also referred to as prestressed steel strand.
- Pyrite staining** - A pale brass-yellow colored stain in the concrete caused from the concrete mixture containing an excess amount of iron disulfides.
- Reinforcing steel** - Any steel for the purpose of reinforcement of the concrete, including longitudinal reinforcement, spiral reinforcement, and deformed reinforcing bars.
- Release strength** - The minimum concrete strength that is necessary before the pretensioned strands can be released.
- Secondary stresses** - The additional stresses created by continued application of the loads as the structure displaces or deflects from its unloaded position.

EFFECTIVE DATE:	ISSUED: 	APPROVED: 
-----------------	---	---

 <b>GUAM POWER AUTHORITY</b> <b>HAGATNA, GUAM</b>	<b>SPECIFICATION E-035</b>	Page 38 of 53
		January 15, 2013
		REV. 2
PREPARED BY THE ENGINEERING DEPARTMENT		

- Service load - The loading which is usually synonymous to the NESC district loadings without load factors applied, and sometimes referred to as unfactored district load or working load. The service load may also be a greater ice and/or wind load when compared to the NESC district loads. Any service load, multiplied by the appropriate load factor will give the ultimate load.
- Spiral reinforcement - Steel reinforcement, continuously wound in the form of a cylindrical helix, that encloses the longitudinal steel.
- Spun concrete pole - A pole which is manufactured by placing prestressed steel strands and spiral reinforcement in a mold, adding fresh concrete and spinning the mold to form the pole.
- Structural designer - The engineer(s) responsible for structural design of the poles, usually employed by or is a hired consultant of a company which fabricates concrete pole structures.
- Ultimate load - The maximum design load which includes the appropriate load factor specified.
- Ultimate moment capacity - The moment which is developed in the pole at the time the ultimate strength of the structure is realized.
- Unbalanced lateral load - Any loading of a significant duration and magnitude which is not restrained or offset by guys or cables which generates bending moments along a section of the pole.
- Ultimate strength - The maximum strength in the stress-strain diagram. For the pole, this is considered to be the point at which the pole fails, usually with crushing of the concrete.
- Unfactored district load - See Service Load.
- Unfactored extreme load - The extreme wind, ice, or other extreme loading without considering a load factor.
- Unfactored load - A loading in which the load factor has not been applied.
- Working load - See Service Load.
- Yield strength - The minimum stress at which a material will start to physically deform without further increase in load or which produces a permanent strain. This is known as the elastic limit of the material.
- Zero tension strength - The moment at which a crack that was previously created by exceeding the cracking moment strength will open again. Under this condition, an applied moment will not cause any tensile stress in the concrete. It will always be less than the cracking moment strength.

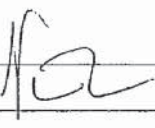
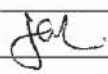
EFFECTIVE DATE: 1/21/13	ISSUED: 	APPROVED: 
-------------------------	---	---

 GUAM POWER AUTHORITY HAGATNA, GUAM PREPARED BY THE ENGINEERING DEPARTMENT	SPECIFICATION E-035	Page 39 of 53
		January 15, 2013
		REV. 2

APPENDIX B POLE TEST SET-UP

POLE TEST SETUP

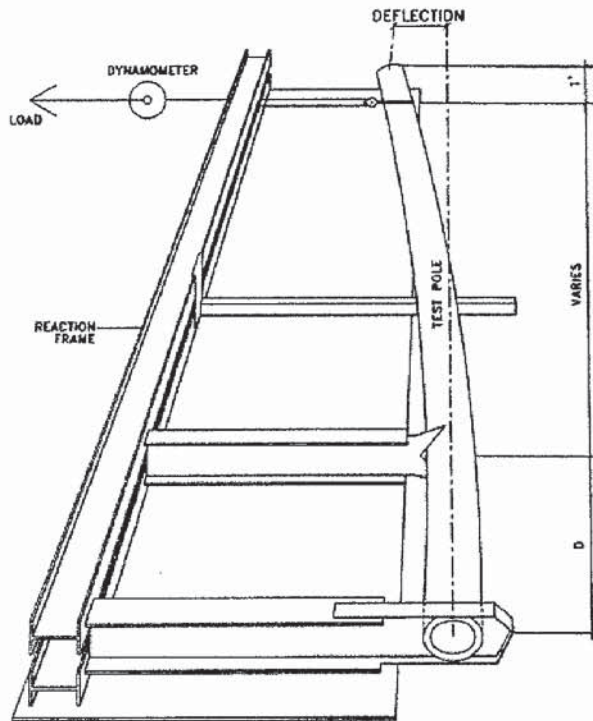

POLE HEIGHT	DEPTH D
35'-0"	6'-0"
45'-0"	7'-0"
55'-0"	8'-0"

EFFECTIVE DATE: 1/21/13	ISSUED: <i>FL</i>	APPROVED: <i>JA</i>
-------------------------	-------------------	---------------------



 GUAM POWER AUTHORITY HAGATNA, GUAM PREPARED BY THE ENGINEERING DEPARTMENT	<b>SPECIFICATION E-035</b>	Page 40 of 53
		January 15, 2013
		REV. 2

APPENDIX B1 CLASS A TEST LOADS

CLASS A – SELF-SUPPORTING POLES

HORIZONTAL DEFLECTION ANGLE (Θ)	45' POLE HORIZONTAL LOADS		55' POLE HORIZONTAL LOADS	
	WORKING STRESS (KIPS)	ULTIMATE STRENGTH (KIPS)	WORKING STRESS (KIPS)	ULTIMATE STRENGTH (KIPS)
5°	5.63	7.18	9.79	12.48
10°	5.79	7.38	10.33	13.17
15°	5.93	7.56	10.85	13.83
20°	6.07	7.74	11.34	14.46
25°	6.19	7.90	11.81	15.06
30°	6.31	8.04	12.24	15.61
35°	6.41	8.17	12.64	16.11
40°	6.49	8.28	12.99	16.56
45°	6.56	8.37	13.30	16.96
50°	6.62	8.44	13.56	17.29
55°	6.66	8.49	13.78	17.56
60°	6.68	8.51	13.94	17.77
65°	6.68	8.52	14.05	17.91
70°	6.67	8.50	14.10	17.98
75°	6.63	8.45	14.09	17.97
80°	6.58	8.39	14.03	17.89
85°	6.51	8.30	13.91	17.73
90°	6.42	8.18	13.73	17.51

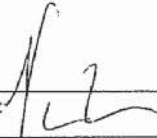
NOTE: ABOVE VALUES ARE BASED ON 200 FEET POLE SPACING.

EFFECTIVE DATE: 1/31/13	ISSUED: 	APPROVED: 
-------------------------	---	---

 GUAM POWER AUTHORITY HAGATNA, GUAM PREPARED BY THE ENGINEERING DEPARTMENT	<b>SPECIFICATION E-035</b>	Page 41 of 53
		January 15, 2013
		REV. 2

APPENDIX B2 CLASS B TEST LOADS

CLASS B – GUYED POLES

HORIZONTAL DEFLECTION ANGLE (Θ)	35° POLE HORIZONTAL LOADS		45° POLE HORIZONTAL LOADS		55° POLE HORIZONTAL LOADS	
	WORKING STRESS (KIPS)	ULTIMATE STRENGTH (KIPS)	WORKING STRESS (KIPS)	ULTIMATE STRENGTH (KIPS)	WORKING STRESS (KIPS)	ULTIMATE STRENGTH (KIPS)
5°	4.52	5.76	5.34	6.80	9.14	11.65
10°	4.51	5.75	5.33	6.79	9.12	11.62
15°	4.50	5.73	5.31	6.77	9.08	11.58
20°	4.47	5.70	5.29	6.75	9.04	11.52
25°	4.45	5.67	5.26	6.71	8.98	11.45
30°	4.41	5.63	5.23	6.67	8.91	11.36
35°	4.37	5.58	5.19	6.62	8.83	11.26
40°	4.33	5.52	5.14	6.56	8.73	11.13
45°	4.28	5.46	5.09	6.49	8.63	11.00
50°	4.22	5.38	5.03	6.42	8.51	10.85
55°	4.16	5.31	4.97	6.34	8.38	10.68
60°	4.09	5.22	4.90	6.25	8.23	10.50
65°	4.02	5.13	4.83	6.16	8.08	10.30
70°	3.94	5.03	4.75	6.06	7.92	10.09
75°	3.86	4.92	4.67	5.95	7.74	9.87
80°	3.77	4.81	4.58	5.84	7.56	9.63
85°	3.68	4.69	4.49	5.72	7.36	9.38
90°	3.59	4.57	4.39	5.60	7.16	9.12

NOTE: ABOVE VALUES ARE BASED ON 200 FEET POLE SPACING.

EFFECTIVE DATE: 1/31/13	ISSUED: 	APPROVED: 
-------------------------	---	---

 GUAM POWER AUTHORITY HAGATNA, GUAM PREPARED BY THE ENGINEERING DEPARTMENT	SPECIFICATION E-035	Page 42 of 53
		January 15, 2013
		REV. 2

APPENDIX C CONCRETE POLE TEST PROCEDURE

TEST PROCEDURE FOR TESTING CONCRETE  
 POLES SUPPLIED TO THE GUAM POWER AUTHORITY

1.0 SELECTION OF TEST SPECIMENS

A GPA representative shall select two poles of each design at random to be tested. If testing is not to be performed immediately after selection, the poles selected shall be suitably marked.

2.0 INSPECTION AND DIMENSION VERIFICATION

- 2.1. A GPA representative shall measure pole lengths and pole diameters, measure the amount of concrete cover over the steel reinforcement, and count the number of reinforcing rods and wires to ensure compliance with the approved design and Sections 5.0 and 9.0.
- 2.2. A GPA representative shall check all hole locations and sizes to ensure compliance with the Sections 5.0 and 9.0. Refer to Appendices A1 and A2 of this specification.

3.0 BENDING TEST

- 3.1. Place the pole in a test support or test frame with the lower end of the pole at a distance "D" held firmly in place as indicated in the pole test set-up. If the test is to be in the horizontal position, provisions shall be made by suitable supports to minimize the bending moment induced by the weight of the pole.
- 3.2. Set the deflection measurement instruments at the top of the pole. Mark the pole so that the deflection can be measured.
- 3.3. Using a dynamometer apply the loading gradually to allow observation of the formation of cracks and the measuring of deflection. The load should be applied one foot from the top of the pole. Record the amount of deflection after each load increment is made. Check for cracking, measure the cracks found, and provide a sketch indicating location and size of cracks. Provide a written record of loading, deflection and appearance of first hairline crack.
- 3.4. When the test load reaches the service test load, release the load after recording the amount of deflection and observing and recording any cracks. After the load is released, record the permanent residual deflection (if any). The accuracy of the measurements shall be within 0.125 inch.
- 3.5. Repeat Steps 3.3 and 3.4 for 60%, 85% and 100% of ultimate horizontal load checking for visible cracking at service load. Visible sign of cracking at service load level shall be the cause for rejection.

4.0 BREAKING TEST

- 4.1. After completion of the bending strength test, the pole tested in Section 3.0 above shall be subjected to a breaking load test.
- 4.2. With the same pole secured in place, apply sufficient loading (use moderate load increments) to break the test pole. Provide suitable load recording equipment to record the maximum load applied prior to breakage.
- 4.3. The breaking load must equal or exceed the calculated ultimate moment capacity (of the section at D distance from the butt of the pole) divided by the moment arm (pole length - (D+1)):

EFFECTIVE DATE: 1/31/13	ISSUED: 	APPROVED: 
-------------------------	---	---

 GUAM POWER AUTHORITY HAGATNA, GUAM PREPARED BY THE ENGINEERING DEPARTMENT	<b>SPECIFICATION E-035</b>	Page 43 of 53
		January 15, 2013
		REV. 2

Breaking load  $\geq$  Ultimate Moment Capacity  
 $PL - (D + 1)$

4.4. Non-attainment of this breaking load criterion shall be the cause for rejection.

5.0 Repeat sections 2.0 and 3.0 for the second pole selected. The second pole, having been subjected to bending loads only, may be used for the breaking test provided it passes the bending tests.

NOTE: Cracking shall be allowed at one half the Ultimate Moment Capacity of the pole.

EFFECTIVE DATE: 1/21/13	ISSUED: 	APPROVED: 
-------------------------	---	---

 GUAM POWER AUTHORITY HAGATNA, GUAM PREPARED BY THE ENGINEERING DEPARTMENT	<b>SPECIFICATION E-035</b>	Page 44 of 53
		January 15, 2013
		REV. 2

APPENDIX D BASIC DESIGN CRITERIA

A. Codes And References

1. ACI 318-08 Building Code Requirements For Reinforced Concrete
2. International Building Code - 2009
3. ACI Detailing Manual
4. AISC 9<sup>th</sup> Edition

B. Materials Stresses

- |                                     |                      |
|-------------------------------------|----------------------|
| 1. Prestressed Concrete Pole        | $f'_c = 6,000$ psi   |
| At Release of Strand                | $f'_c = 4,500$ psi   |
| 2. Prestressing Steel               | ASTM A416, Grade 270 |
| 3. Reinforced Concrete (Foundation) | $f'_c = 3,000$ psi   |
| 4. Spiral Wire                      | ASTM A82             |
| 5. Rebar                            | ASTM A615, Grade 60  |

C. Loadings

- |  |  |
|--|--|
| 1. Wind Load                           |  |
| Wind Velocity (sustained)              | 155 mph                                  |
| Wind Velocity (3 second gusts)         | 170 mph                                  |
| Wind Exposure Coefficient              | C  |
| Importance Factor                      | $I = .1.15$                              |
| 2. Seismic Load                        |  |
| Mapped Spectral Response Accelerations | $S_s = 1.5$                              |
|  | $S_1 = 0.6$                              |
| Importance Factor                      | $I = 1.25$                               |
| Site Class                             | Assume D if Geotechnical data is unknown |

EFFECTIVE DATE: 1/31/13	ISSUED: 	APPROVED: 
-------------------------	---	---



 GUAM POWER AUTHORITY HAGATNA, GUAM PREPARED BY THE ENGINEERING DEPARTMENT	<b>SPECIFICATION E-035</b>	Page 45 of 53
		January 15, 2013
		REV. 2

APPENDIX E CLASS A OR B – 55 FOOT CONCRETE POLE INSPECTION FORM

TEST DATE: \_\_\_\_/\_\_\_\_/\_\_\_\_ TEST LOCATION: \_\_\_\_\_  
 City, Country

TYPE OF POLE: \_\_\_\_\_ POLE MANUFACTURER: \_\_\_\_\_

DIMENSION CHECK	MEASURED	PER SPEC E-035
Weight of pole:	_____	
Pole height:	_____	55- 0"
Pole top diameter:	_____	12" min – 18" max
Pole butt diameter:	_____	20" min – 28" max
Number of 11/16 inch holes:	_____	20 each
Number of 13/16 inch holes:	_____	11 each
Number of 2 inch ground sleeves:	_____	4 each

HOLE SPACINGS:

\* denotes 3/16" diameter holes

FROM	TO	MEASURED	E-035	FROM	TO	MEASURED	E-035
TIP	A	_____	10 1/4"	P	Q	_____	3' – 6"
A	*B	_____	1' – 0"	Q	R	_____	9"
*B	*C	_____	10"	R	S	_____	11 3/8"
*C	*D	_____	10 3/8"	S	T	_____	1' – 0 3/4"
*D	*E	_____	10"	T	U	_____	9"
*E	*F	_____	10"	U	V	_____	11 3/8"
*F	*G	_____	8'	V	W	_____	8 3/4"
*G	*H	_____	10 3/8"	W	X	_____	1' – 0"
*H	*I	_____	10"	X	Y	_____	1' – 0"
*I	*J	_____	10"	Y	Z	_____	1' – 0"
*J	*K	_____	10 3/8"	Z	Z1	_____	1' – 0"
*K	*L	_____	10"	Z1	Z2	_____	1' – 0"
*L	M	_____	8"	Z2	Z3	_____	1' – 0"
M	N	_____	10"	Z3	Z4	_____	1' – 0"
N	O	_____	10 3/8"	Z4	Ground	_____	15' – 10"
O	P	_____	1' – 0"		Hole		

Material for hole inserts (Section 9.3): \_\_\_\_\_

Concrete cover over reinforcement: \_\_\_\_\_ inches (exterior side) & \_\_\_\_\_ inches (interior side)

Reinforcing type, amount and placement

Conforms with the approved Shop Drawings? [ ] YES [ ] NO

Longitudinal center of gravity provided? [ ] YES [ ] NO

Pole birthmark provided? [ ] YES [ ] NO

EFFECTIVE DATE: 1/31/13	ISSUED: 	APPROVED: 
-------------------------	---	---

 GUAM POWER AUTHORITY HAGATNA, GUAM PREPARED BY THE ENGINEERING DEPARTMENT	<b>SPECIFICATION E-035</b>	Page 46 of 53
		January 15, 2013
		REV. 2

CLASS A OR B – 45 FOOT CONCRETE POLE INSPECTION FORM

TEST DATE: \_\_\_\_/\_\_\_\_/\_\_\_\_ TEST LOCATION: \_\_\_\_\_  
 City, Country

TYPE OF POLE: \_\_\_\_\_ POLE MANUFACTURER: \_\_\_\_\_

DIMENSION CHECK	MEASURED	PER SPEC E-035
Weight of pole:	_____	
Pole height:	_____	45- 0"
Pole top diameter:	_____	12" min
Pole butt diameter:	_____	18 5/8" min – 20" max
Number of 11/16 inch holes:	_____	14 each
Number of 2 inch ground sleeves:	_____	4 each

HOLE SPACINGS:

FROM	TO	MEASURED	E-035
TIP	A	_____	1' – 0"
A	B	_____	9 3/8"
B	C	_____	11"
C	D	_____	10"
D	E	_____	1' – 8 3/8"
E	F	_____	2' – 0"
F	G	_____	11 1/4"
G	H	_____	1' – 0"
H	I	_____	2' – 0"
I	J	_____	1' – 0"
J	K	_____	10"
K	L	_____	5' – 2"
L	M	_____	1' – 0"
M	Ground	_____	16' – 10"

Hole

Material for hole inserts (Section 9.3): \_\_\_\_\_

Concrete cover over reinforcement: \_\_\_\_\_ inches (exterior side) & \_\_\_\_\_ inches (interior side)

Reinforcing type, amount and placement

- Conforms with the approved Shop Drawings? [ ] YES [ ] NO  
 Longitudinal center of gravity provided? [ ] YES [ ] NO  
 Pole birthmark provided? [ ] YES [ ] NO

EFFECTIVE DATE: 1/15/13	ISSUED: 	APPROVED: 
-------------------------	---	---

 <b>GUAM POWER AUTHORITY</b> HAGATNA, GUAM PREPARED BY THE ENGINEERING DEPARTMENT	<b>SPECIFICATION E-035</b>	Page 47 of 53
		January 15, 2013
		REV. 2

CLASS A OR B – 35 FOOT CONCRETE POLE INSPECTION FORM

TEST DATE: \_\_\_\_/\_\_\_\_/\_\_\_\_ TEST LOCATION: \_\_\_\_\_  
City, Country

TYPE OF POLE: \_\_\_\_\_ POLE MANUFACTURER: \_\_\_\_\_

DIMENSION CHECK	<u>MEASURED</u>	<u>PER SPEC E-035</u>
Weight of pole:	_____	
Pole height:	_____	35- 0"
Pole top diameter:	_____	12" min
Pole butt diameter:	_____	17 5/8" min – 20" max
Number of 11/16 inch holes:	_____	9 each
Number of 2 inch ground sleeves:	_____	3 each

HOLE SPACINGS:

FROM	TO	<u>MEASURED</u>	<u>E-035</u>
TIP	A	_____	9"
A	B	_____	10"
B	C	_____	10 3/8"
C	D	_____	1' – 0"
D	E	_____	1' – 0"
E	F	_____	1' – 8 3/8"
F	G	_____	5' – 0"
G	H	_____	9"
H	Ground	_____	15' – 1 1/4"

Hole

Material for hole inserts (Section 9.3): \_\_\_\_\_

Concrete cover over reinforcement: \_\_\_\_\_ inches (exterior side) & \_\_\_\_\_ inches (interior side)

Reinforcing type, amount and placement

Conforms with the approved Shop Drawings? [ ] YES [ ] NO

Longitudinal center of gravity provided? [ ] YES [ ] NO

Pole birthmark provided? [ ] YES [ ] NO

EFFECTIVE DATE: 1/31/13	ISSUED: 	APPROVED: 
-------------------------	---	---

 <b>GUAM POWER AUTHORITY</b> HAGATNA, GUAM PREPARED BY THE ENGINEERING DEPARTMENT	<b>SPECIFICATION E-035</b>	Page 48 of 53
		January 15, 2013
		REV. 2

**CLASS A 55 - FOOT Pole  
Concrete Pole Bending Test Form**

55' Pole Horizontal Loads						
Service Stress (service load level)	Deflection Measured (FEET)		Remarks for Service Stress	Ultimate Strength	Deflection Measured (FEET)	
Kips	(A)	(B)	(visible cracks)	Kips	(A)	(B)
1st. pull	12.24			15.61 (60%)		
2nd. pull	13.30			16.96 (85%)		
3rd. pull	14.10			17.98 (100%)		

Note: 1. Visible cracking at service load level shall be cause for pole rejection.  
 2. Do not perform breaking test unless passes bending test.

**Concrete Pole Breaking Test**

Breaking Load Stress >  $\frac{\text{Ultimate Moment Capacity}}{PL-(D+1)} = \underline{\hspace{2cm}}$

Ultimate Moment Capacity = Provide by Structural Engineer in Design Calculation .  
 \*Non-attainment of this breaking load criteria shall be cause for pole rejection.

- 4th. pull • Calculated Breaking Load Stress \_\_\_\_\_ Kips, (A) = \_\_\_\_\_ .
- Breaking of concrete pole measured @ maximum Stress Load applied/ pull \_\_\_\_\_ Kips, (A) = \_\_\_\_\_ .

**Concrete Pole Setup**

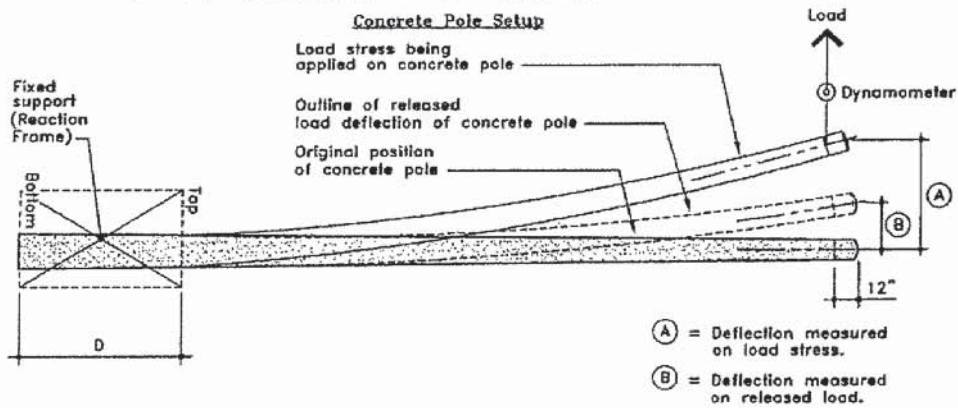

PL (Pole length) = 55'-0" and D (Depth) = 8'-0"

No. of cracks found \_\_\_\_\_, No. cracks <0.01 inch found \_\_\_\_\_ and No. cracks >0.01 inch found \_\_\_\_\_.  
 Draw in approximate location of cracks and indicate measurement.

EFFECTIVE DATE: 1/31/13	ISSUED: 	APPROVED: 
-------------------------	---	---

 <b>GUAM POWER AUTHORITY</b> HAGATNA, GUAM PREPARED BY THE ENGINEERING DEPARTMENT	<b>SPECIFICATION E-035</b>	Page 49 of 53
		January 15, 2013
		REV. 2

**CLASS B 55 - FOOT Pole**  
**Concrete Pole Bending Test Form**

	55' Pole Horizontal Loads						
	Service Stress (service load level) Kips	Deflection Measured (FEET)		Remarks for Service Stress (visible cracks)	Ultimate Strength Kips	Deflection Measured (FEET)	
		(A)	(B)			(A)	(B)
1st. pull	8.38				10.68 (60%)		
2nd. pull	8.83				11.26 (85%)		
3rd. pull	9.14				11.65 (100%)		

Note: 1. Visible cracking at service load level shall be cause for pole rejection.  
 2. Do not perform breaking test unless passes bending test.

**Concrete Pole Breaking Test**

Breaking Load Stress >  $\frac{\text{Ultimate Moment Capacity}}{PL - (D+1)}$  = \_\_\_\_\_

Ultimate Moment Capacity = Provide by Structural Engineer in Design Calculation .  
 \*Non-attainment of this breaking load criteria shall be cause for pole rejection.

- 4th. pull
- Calculated Breaking Load Stress \_\_\_\_\_ Kips, (A) = \_\_\_\_\_ .
  - Breaking of concrete pole measured @ maximum Stress Load applied/ pull \_\_\_\_\_ Kips, (A) = \_\_\_\_\_ .

**Concrete Pole Setup**

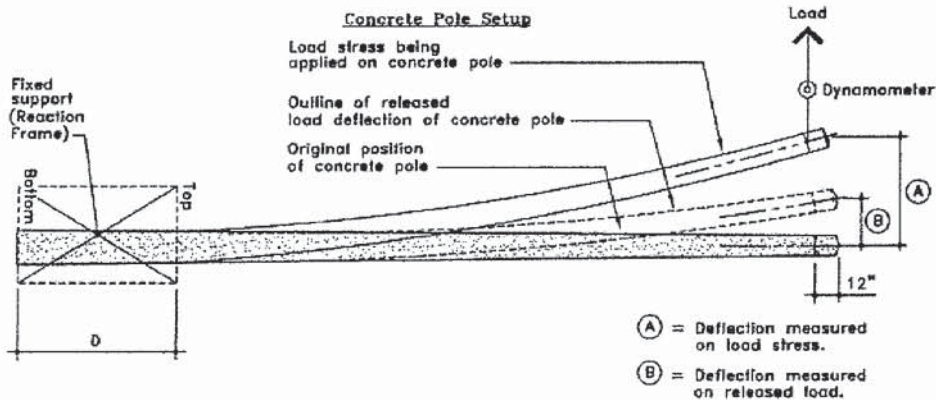

PL (Pole length) = 55'-0" and D (Depth) = 8'-0"

No. of cracks found \_\_\_\_\_, No. cracks <0.01 inch found \_\_\_\_\_ and No. cracks >0.01 inch found \_\_\_\_\_.  
 Draw in approximate location of cracks and indicate measurement.

EFFECTIVE DATE: 1/31/13	ISSUED: 	APPROVED: 
-------------------------	---	---

 <b>GUAM POWER AUTHORITY</b> HAGATNA, GUAM PREPARED BY THE ENGINEERING DEPARTMENT	<b>SPECIFICATION E-035</b>	Page 50 of 53
		January 15, 2013
		REV. 2

**CLASS A 45' - FOOT Pole  
Concrete Pole Bending Test Form**

	45' Pole Horizontal Loads						
	Service Stress (service load level) Kips	Deflection Measured (FEET)		Remarks for Service Stress	Ultimate Strength Kips	Deflection Measured (FEET)	
		(A)	(B)	(visible cracks)		(A)	(B)
1st. pull	6.31				8.04 (60%)		
2nd. pull	6.49				8.24 (85%)		
3rd. pull	6.68				8.52 (100%)		

Note: 1. Visible cracking at service load level shall be cause for pole rejection.  
 2. Do not perform breaking test unless passes bending test.

**Concrete Pole Breaking Test**

Breaking Load Stress >  $\frac{\text{Ultimate Moment Capacity}}{PL-(D+1)} = \underline{\hspace{2cm}}$

Ultimate Moment Capacity = Provide by Structural Engineer in Design Calculation .  
 \*Non-attainment of this breaking load criteria shall be cause for pole rejection.

- 4th. pull • Calculated Breaking Load Stress  $\underline{\hspace{2cm}}$  Kips, (A) =  $\underline{\hspace{2cm}}$  .  
 • Breaking of concrete pole measured @ maximum Stress Load applied/ pull  $\underline{\hspace{2cm}}$  Kips, (A) =  $\underline{\hspace{2cm}}$  .

**Concrete Pole Setup**

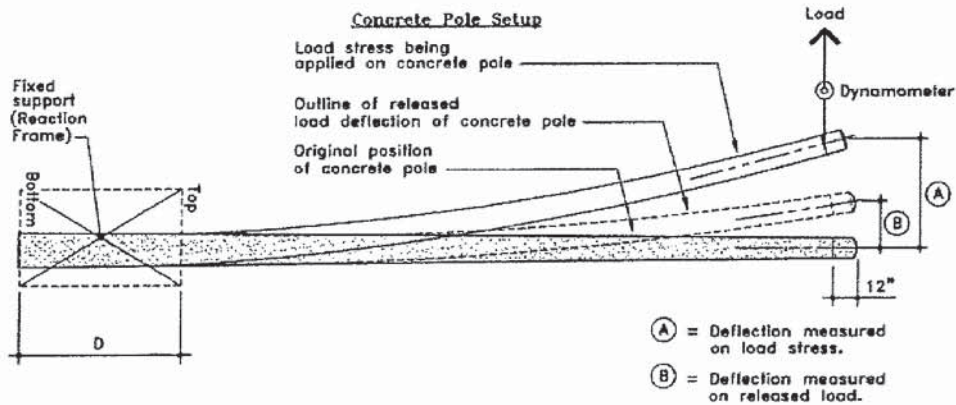

PL (Pole length) = 45'-0" and D (Depth) = 7'-0"

No. of cracks found  $\underline{\hspace{1cm}}$ , No. cracks <0.01 inch found  $\underline{\hspace{1cm}}$  and No. cracks >0.01 inch found  $\underline{\hspace{1cm}}$ .  
 Draw in approximate location of cracks and indicate measurement.

EFFECTIVE DATE: 1/21/13	ISSUED: [Signature]	APPROVED: [Signature]
-------------------------	---------------------	-----------------------

 <b>GUAM POWER AUTHORITY</b> HAGATNA, GUAM PREPARED BY THE ENGINEERING DEPARTMENT	<b>SPECIFICATION E-035</b>	Page 51 of 53
		January 15, 2013
		REV. 2

**CLASS B 45 - FOOT Pole  
Concrete Pole Bending Test Form**

45' Pole Horizontal Loads						
Service Stress (service load level)	Deflection Measured (FEET)		Remarks for Service Stress	Ultimate Strength	Deflection Measured (FEET)	
Kips	(A)	(B)	(visible cracks)	Kips	(A)	(B)
1st. pull	4.97			6.34 (60%)		
2nd. pull	5.19			6.62 (85%)		
3rd. pull	5.34			6.80 (100%)		

Note: 1. Visible cracking at service load level shall be cause for pole rejection.  
 2. Do not perform breaking test unless passes bending test.

Concrete Pole Breaking Test

Breaking Load Stress >  $\frac{\text{Ultimate Moment Capacity}}{PL-(D+1)} = \underline{\hspace{2cm}}$

Ultimate Moment Capacity = Provide by Structural Engineer in Design Calculation .  
 \*Non-attainment of this breaking load criteria shall be cause for pole rejection.

- 4th. pull
- Calculated Breaking Load Stress \_\_\_\_\_ Kips, (A) = \_\_\_\_\_ .
  - Breaking of concrete pole measured @ maximum Stress Load applied/ pull \_\_\_\_\_ Kips, (A) = \_\_\_\_\_ .

Concrete Pole Setup

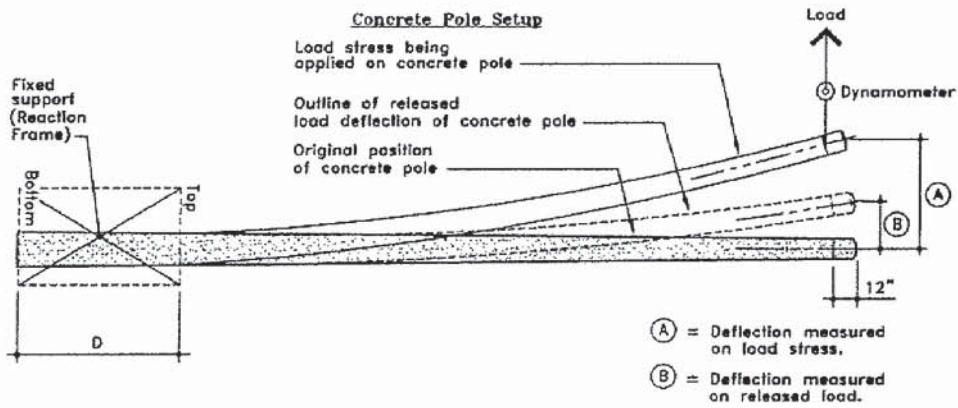

PL (Pole length) = 45'-0" and D (Depth) = 7'-0"

No. of cracks found \_\_\_\_\_, No. cracks <0.01 inch found \_\_\_\_\_ and No. cracks >0.01 inch found \_\_\_\_\_.  
 Draw in approximate location of cracks and indicate measurement.

EFFECTIVE DATE: 1/21/13	ISSUED: 	APPROVED: 
-------------------------	---	---

 <b>GUAM POWER AUTHORITY</b> HAGATNA, GUAM PREPARED BY THE ENGINEERING DEPARTMENT	<b>SPECIFICATION E-035</b>	Page 52 of 53
		January 15, 2013
		REV. 2

**CLASS 35 - FOOT Pole**  
**Concrete Pole Bending Test Form**

	35' Pole Horizontal Loads						
	Service Stress (service load level) Kips	Deflection Measured (FEET)		Remarks for Service Stress (visible cracks)	Ultimate Strength Kips	Deflection Measured (FEET)	
		(A)	(B)			(A)	(B)
1st. pull	4.16				5.31 (60%)		
2nd. pull	4.37				5.58 (85%)		
3rd. pull	4.52				5.76 (100%)		

Note: 1. Visible cracking at service load level shall be cause for pole rejection.  
 2. Do not perform breaking test unless passes bending test.

Concrete Pole Breaking Test

Breaking Load Stress >  $\frac{\text{Ultimate Moment Capacity}}{PL-(D+1)} = \underline{\hspace{2cm}}$

Ultimate Moment Capacity = Provide by Structural Engineer in Design Calculation .  
 \*Non-attainment of this breaking load criteria shall be cause for pole rejection.

- 4th. pull
- Calculated Breaking Load Stress \_\_\_\_\_ Kips, (A) = \_\_\_\_\_ .
  - Breaking of concrete pole measured @ maximum Stress Load applied/ pull \_\_\_\_\_ Kips, (A) = \_\_\_\_\_ .

Concrete Pole Setup

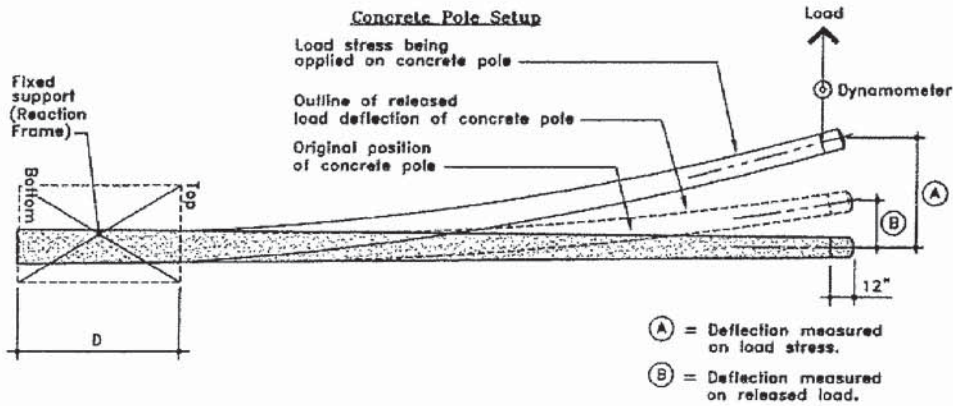

PL (Pole length) = 35'-0" and D (Depth) = 6'-0"

No. of cracks found \_\_\_\_\_, No. cracks <0.01 inch found \_\_\_\_\_ and No. cracks >0.01 inch found \_\_\_\_\_.  
 Draw in approximate location of cracks and indicate measurement.

EFFECTIVE DATE: 1/31/10	ISSUED: 	APPROVED: 
-------------------------	---	---



 GUAM POWER AUTHORITY HAGATNA, GUAM PREPARED BY THE ENGINEERING DEPARTMENT	<b>SPECIFICATION E-035</b>	Page 53 of 53
		January 15, 2013
		REV. 2

APPENDIX F TESTING OF CONCRETE SAMPLE FORM

Number of samples tested: \_\_\_\_\_

STRENGTH TEST RESULTS

SAMPLE NUMBER	AGE	SIZE	LOADING AT FAILURE	COMPRESSIVE STRENGTH
1	_____	_____	_____	_____
2	_____	_____	_____	_____
3	_____	_____	_____	_____
4	_____	_____	_____	_____
5	_____	_____	_____	_____
6	_____	_____	_____	_____
7	_____	_____	_____	_____
8	_____	_____	_____	_____
9	_____	_____	_____	_____
10	_____	_____	_____	_____

FOR GUAM POWER AUTHORITY

\_\_\_\_\_  
 \_\_\_\_\_  
 \_\_\_\_\_  
 \_\_\_\_\_

EFFECTIVE DATE: 1/31/13	ISSUED: 	APPROVED: 
-------------------------	---	---



# GUAM POWER AUTHORITY

ATURIDÁT ILEKTRESEDÁT GUAHAN  
P.O.BOX 2977 • AGANA, GUAM U.S.A. 96932-2977

Edward J.B. Calvo  
Governor

Telephone Nos. (671) 648-3054/55 Fax: 648-3165

Raymond S. Tenorio  
Lieutenant Governor

## BID BOND

NO.: \_\_\_\_\_

KNOW ALL MEN BY THESE PRESENTS that \_\_\_\_\_, as

Principal Hereinafter called the Principal, and (Bonding Company), \_\_\_\_\_  
A duly admitted insurer under the laws of the Territory of Guam, as Surety, hereinafter called the Surety are  
Held firmly bound unto the Territory of Guam for the sum of \_\_\_\_\_ Dollars  
(\$ \_\_\_\_\_), for Payment of which sum will and truly to be made, the said Principal and the said  
Surety bind ourselves, our heirs, executors, administrators, successors and assigns, jointly and severally, firmly  
by these presents.

WHEREAS, the Principal has submitted a bid for (identify project by number and brief description)

\_\_\_\_\_  
\_\_\_\_\_

NOW, THEREFORE, if the Territory of Guam shall accept the bid of the Principal and the Principal shall  
enter into a Contract with the Territory of Guam in accordance with the terms of such bid, and give such bond or  
bonds as my be specified in bidding or Contract documents with good and sufficient surety for the faithful  
performance of such Contract Documents with good and sufficient surety for the faithful performance of such  
Contract and for the prompt payment of labor and material furnished in the prosecution thereof, or in the event  
of the failure of the Principal to enter such Contract and give such bond or bonds, if the Principal shall pay to the  
Territory of Guam the difference not to exceed the penalty hereof between the amounts specified in said bid  
and such larger amount for which the Territory of Guam may in good faith contract with another party to perform  
work covered by said bid or an appropriate liquidated amount as specified in the Invitation for Bids then this  
obligation shall be null and void, otherwise to remain full force and effect.

Signed and sealed this \_\_\_\_\_ day of \_\_\_\_\_ 2017.

\_\_\_\_\_  
(PRINCIPAL) (SEAL)

\_\_\_\_\_  
(WITNESS)

\_\_\_\_\_  
(TITLE)

\_\_\_\_\_  
(MAJOR OFFICER OF SURETY)

\_\_\_\_\_  
(TITLE)

\_\_\_\_\_  
(TITLE)

\_\_\_\_\_  
(RESIDENT GENERAL AGENT)

SEE INSTRUCTIONS FOR SUPPORTING DOCUMENTS REQUIRED.

**INSTRUCTION TO PROVIDERS:**

NOTICE to all Insurance and Bonding Institutions:

The Bond requires the signatures of the Vendor, two (2) major Officers of the Surety and Resident General Agent, if the Surety is a foreign or alien surety.

When the form is submitted to the Guam Power Authority, it should be accompanied with copies of the following:

1. Current Certificate of Authority to do business on Guam issued by the Department of Revenue and Taxation.
2. Power of Attorney issued by the Surety to the Resident General Agent.
3. Power of Attorney issued by two (2) major officers of the Surety to whoever is signing on their behalf.

Bonds, submitted as Bid Guarantee, without signatures and supporting documents are invalid and Bids will be rejected.



## GUAM POWER AUTHORITY

ATURIDAT ILEKTRESEDAT GUAHAN  
P O BOX 2977, AGANA, GUAM 96932-2977

### SPECIAL PROVISION FOR MAJOR SHAREHOLDERS DISCLOSURE AFFIDAVIT

All Bidders/Offerors are required to submit a current affidavit as required below. Failure to do so will mean disqualification and rejection of the bid/rfp.

5 GCA §5233 (Title 5, Section 5233) states:

"Section 5233 Disclosure of Major Shareholders. As a condition of submitting a bid or offer, any partnership, sole proprietorship or corporation doing business with the government of Guam shall submit an affidavit executed under oath that lists the name and address of any person who has held more than ten percent (10%) of the outstanding interest or shares in said partnership, sole proprietorship or corporation at any time during the twelve (12) month period immediately preceding submission of a bid, or, that it is a not for profit organization that qualifies for tax exemption under the Internal Revenue Code of the United States or the Business Privilege Tax law of Guam, Title 12, Guam Code Annotated, Section 26203©. With the exception of not for profit organizations, the affidavit shall contain the number of shares or the percentage of all assets of such partnership, sole proprietorship or corporation which have held by each such person during the twelve (12) month period. In addition, the affidavit shall contain the name and address of any person who has received or is entitled to receive a commission, gratuity or other compensation for procuring or assisting in obtaining business related to the bid or offer and shall also contain the amounts of any such commission, gratuity or other compensation. The affidavit shall be open and available to the public for inspection and copying."

1. If the affidavit is a copy, indicate the BID/RFP number and where it is filed.
2. Affidavits must be signed within 60 days of the date the bids or proposals are due.

MAJOR SHAREHOLDERS OF DISCLOSURE AFFIDAVIT

TERRITORY OF GUAM)  
HAGATNA, GUAM )

I, undersign, \_\_\_\_\_  
(partner or officer of the company of, etc.)  
being first duly sworn, deposes and says:

- 1. That the person who have held more than ten percent (10%) of the company's shares during the past twelve (12) months are as follows:

<u>Name</u>	<u>Address</u>	<u>Percentage of Shares Held</u>
_____	_____	_____
_____	_____	_____
_____	_____	_____
_____	_____	_____
Total number of shares		_____

- 2. Persons who have received or are entitled a commission, gratuity or other compensation for procuring or assisting in obtaining business related to the bid/rfp for which this Affidavit is submitted are as follows:

<u>Name</u>	<u>Address</u>	<u>Amount of Commission Gratuity or other Compensation</u>
_____	_____	_____
_____	_____	_____

Further, affiant sayeth naught.

Date: \_\_\_\_\_

\_\_\_\_\_  
Signature of individual if bidder/offeror is a sole Proprietorship; Partner, if the bidder/offeror is a Partnership Officer, if the bidder/offeror is a corporation.

Subscribe and sworn to before me this \_\_\_\_\_ day of \_\_\_\_\_,

20\_\_\_\_\_.

Notary Public \_\_\_\_\_

In and for the Territory of Guam

My Commission expires \_\_\_\_\_.

NON-COLLUSION AFFIDAVIT

Guam )  
 )ss:  
Hagatna )

I, \_\_\_\_\_ first being duly sworn, depose and say:  
(Name of Declarant)

1. That I am the \_\_\_\_\_ of \_\_\_\_\_  
(Title) (Name of Bidding/RFP Company)
2. That in making the foregoing proposal or bid, that such proposal or bid is Genuine and not collusive or shame, that said bidder/offeror has not colluded, Conspired, connived or agreed, directly or indirectly, with any bidder or person, to put in a sham or to refrain from bidding or submitting a proposal and has not in any manner, directly or indirectly, sought by agreement or collusion, or communication or conference, with any person, to fix the bid of affiant or any other bidder, or to secure any overhead, project or cost element of said bid price, or of that of any bidder, or to secure any advantage against the GUAM POWER AUTHORITY or any person interested in the proposed contract; and
3. That all statements in said proposal or bid are true.
4. This affidavit is made in compliance with Guam Administrative Rules and Regulations §§3126(b).

\_\_\_\_\_  
(Declarant)

SUBSCRIBED AND SWORN to me before this \_\_\_\_\_ day of \_\_\_\_\_, 2017.

)Seal(

\_\_\_\_\_  
Notary Public

NO GRATUITIES OR KICKBACKS AFFIDAVIT

AFFIDAVIT  
(Offeror)

TERRITORY OF GUAM )

HAGATNA, GUAM )

SS:

\_\_\_\_\_ being first duly sworn, deposes and says:

As the duly authorized representative of the Offeror, that neither I nor of the Offeror's officers, representatives, agents, subcontractors, or employees has or have offered, given or agreed to give any government of Guam employee or former employee, any payment, gift, kickback, gratuity or offer of employment in connection with Offeror's proposal.

\_\_\_\_\_  
Signature of Individual if Proposer is a Sole Proprietorship;  
Partner, if the Proposer is a Partnership;  
Officer, if the Proposer is a Corporation

SUBSCRIBED AND SWORN to before me this \_\_\_\_ day of \_\_\_\_\_, 2017.

\_\_\_\_\_  
Notary Public  
In and for the Territory of Guam  
My Commission Expires:

**ETHICAL STANDARDS AFFIDAVIT**

**AFFIDAVIT**  
(Proposer)

TERRITORY OF GUAM     )  
   )                     SS:  
HAGATNA, GUAM            )

\_\_\_\_\_, being first duly sworn, deposes and says:

That I am ( the Sole Proprietor, a Partner or Officer of the Offeror)

That Offeror making the foregoing Proposal, that neither he or nor of the Offeror’s officers, representatives, agents, subcontractors, or employees of the Offeror have knowingly influenced any government of Guam employee to breach any of the ethical standards set forth in 5 GCA Chapter 5 Article 11, and promises that neither he nor any officer, representative, agent, subcontractor, or employee of Offeror will knowingly influence any government of Guam employee to breach any ethical standard set for in 5 GCA Chapter 5 Article 11.

\_\_\_\_\_  
Signature of Individual if Proposer is a Sole Proprietorship;  
Partner, if the Proposer is a Partnership;  
Officer, if the Proposer is a Corporation

SUBSCRIBED AND SWORN to before me this \_\_\_\_ day of \_\_\_\_\_, 2017.

\_\_\_\_\_  
Notary Public  
In and for the Territory of Guam  
My Commission Expires:



DECLARATION RE-COMPLIANCE WITH U.S. DOL WAGE DETERMINATION

Procurement No.: \_\_\_\_\_

Name of Offeror Company: \_\_\_\_\_

\_\_\_\_\_ hereby certifies under penalty of perjury:

(1) That I am \_\_\_\_\_ (the offeror, a partner of the offeror, an officer of the offeror) making the bid or proposal in the foregoing identified procurement;

(2) That I have read and understand the provisions of 5 GCA § 5801 and § 5802 which read:

**§ 5801. Wage Determination Established.**

In such cases where the government of Guam enters into contractual arrangements with a sole proprietorship, a partnership or a corporation ("contractor") for the provision of a service to the government of Guam, and in such cases where the contractor employs a person(s) whose purpose, in whole or in part, is the direct delivery of service contracted by the government of Guam, then the contractor shall pay such employee(s) in accordance with the Wage Determination for Guam and the Northern Mariana Islands issued and promulgated by the U.S. Department of Labor for such labor as is employed in the direct delivery of contract deliverables to the government of Guam.

The Wage Determination most recently issued by the U.S. Department of Labor at the time a contract is awarded to a contractor by the government of Guam shall be used to determine wages, which shall be paid to employees pursuant to this Article. Should any contract contain a renewal clause, then at the time of renewal adjustments, there shall be made stipulations contained in that contract for applying the Wage Determination, as required by this Article, so that the Wage Determination promulgated by the U.S. Department of Labor on a date most recent to the renewal date shall apply.

**§ 5802. Benefits.**

In addition to the Wage Determination detailed in this Article, any contract to which this Article applies shall also contain provisions mandating health and similar benefits for employees covered by this Article, such benefits having a minimum value as detailed in the Wage Determination issued and promulgated by the U.S. Department of Labor, and shall contain provisions guaranteeing a minimum of ten (10) paid holidays per annum per employee.

(3) That the offeror is in full compliance with 5 GCA § 5801 and § 5802, as may be applicable to the procurement referenced herein;

\_\_\_\_\_  
Signature of Individual if Proposer is a Sole Proprietorship;  
Partner, if the Proposer is a Partnership;  
Officer, if the Proposer is a Corporation

SUBSCRIBED AND SWORN to before me this \_\_\_\_ day of \_\_\_\_\_, 2017.

\_\_\_\_\_  
Notary Public  
In and for the Territory of Guam  
My Commission Expires:

**SPECIAL PROVISIONS**

**Restriction Against Sex Offenders Employed by Service Providers to Government of Guam from Working on Government of Guam Property**

GCA 5 §5253 Restriction Against Contractors Employing Convicted Sex Offenders from Working at Government of Guam Venues:

- (a) No person convicted of a sex offense under the provisions of Chapter 25 of Title 9 Guam Code Annotated, or an offense as defined in Article 2 of Chapter 28, Title 9 GCA in Guam, or an offense in any jurisdiction which includes, at a minimum, all of the elements of said offenses, or who is listed on the Sex Offender Registry, and who is employed by a business contracted to perform services for an agency or instrumentality of the government of Guam, shall work for his employer on the property of the Government of Guam other than public highway.
- (b) All contracts for services to agencies listed herein shall include the following provisions: (1) warranties that no person providing services on behalf of the contractor has been convicted of a sex offense under the provisions of Chapter 25 of Title 9 GCA or an offense as defined in Article 2 of Chapter 28, Title 9 GCA, or an offense in another jurisdiction with, at a minimum, the same elements as such offenses, or who is listed on the Sex Offender Registry; and (2) that if any person providing services on behalf of the contractor is convicted of a sex offense under the provisions of Chapter 25 of Title 9 GCA or an offense as defined in Article 2 of Chapter 28, Title 9 GCA or an offense in another jurisdiction with, at a minimum, the same elements as such offenses, or who is listed on the Sex Offender Registry, that such person will be immediately removed from working at said agency and that the administrator of said agency be informed of such within twenty-four (24) hours of such conviction.
- (c) Duties of the General Services Agency or Procurement Administrators. All contracts, bids, or Requests for Proposals shall state all the conditions in § 5253(b).
- (d) Any contractor found in violation of § 5253(b), after notice from the contracting authority of such violation, shall, within twenty-four (24) hours, take corrective action and shall report such action to the contracting authority. Failure to take corrective action within the stipulated period may result in the temporary suspension of the contract at the discretion of the contracting authority.

*SOURCE: Added by P.L. 28-024:2 ((Apr. 21, 2005). Amended by P.L. 28-098:2 (Feb. 7, 2006).*

\_\_\_\_\_  
Signature of Bidder      Date

Proposer, if an individual;  
Partner, if a partnership;  
Officer, if a corporation.

Subscribed and sworn before me this \_\_\_\_\_ day of \_\_\_\_\_, 2017.

\_\_\_\_\_  
Notary Public



**GUAM POWER AUTHORITY**

ATURIDÁT ILEKTRESEDÁT GUAHAN  
 P.O. BOX 2977 • AGANA, GUAM U.S.A. 96932-2977

Edward J.B. Calvo  
 Governor

Telephone Nos. (671) 648-3054/55 Fax: 648-3165

Raymond S. Tenorio  
 Lieutenant Governor

Accountability · Impartiality · Competence · Openness · Value

**LOCAL PROCUREMENT PREFERENCE APPLICATION**

Based on the law stipulated below, please place a checkmark or an "X" on the block indicating the item that applies to your business:

5GCA, Chapter 5, Section 5008, "Policy in Favor of Local Procurement" of the Guam Procurement Law states:

All procurement of supplies and services shall be made from among businesses licensed to do business on Guam and that maintains an office or other facility on Guam, whenever a business that is willing to be a contractor is:

- ( ) (a) A licensed bonafide manufacturing business that adds at least twenty-five percent (25%) of the value of an item, not to include administrative overhead, suing workers who are U.S. Citizens or lawfully admitted permanent residents or nationals of the United States, or persons who are lawfully admitted to the United States to work, based on their former citizenship in the Trust Territory for the Pacific Islands; or
- ( ) (b) A business that regularly carries an inventory for regular immediate sale of at least fifty percent (50%) of the items of supplies to be procured; or
- ( ) (c) A business that has a bonafide retail or wholesale business location that regularly carries an inventory on Guam of a value of at least one half of the value of the bid or One Hundred Fifty Thousand Dollars (\$150,000.0) whichever is less, of supplies and items of a similar nature to those being sought; or
- ( ) \*(d) A service actually in business, doing a substantial business on Guam, and hiring at least 95% U.S. Citizens, lawfully admitted permanent residents or national of the Unites States, or persons who lawfully admitted to the United States to work, based on their citizenship in any of the nations previously comprising the Trust Territory of the Pacific Islands.

- Bidders indicating qualification under (d) may be considered QUALIFIED for the Local Procurement Preference only if the Government's requirement is for service. Service is defined Pursuant to 5 GCA Government Operations Subparagraph 5030 entitled DEFINITIONS under Chapter 5 of the Guam Procurement Law.

1. I \_\_\_\_\_, representative for \_\_\_\_\_, have read the requirements of the law cited above and do hereby qualify and elect to be given the LOCAL PROCUREMENT PREFERENCE for Bid No.: GPA \_\_\_\_\_.  
 By filling in this information and placing my signature below, I understand that the Guam Power Authority will review this application and provide me with a determination whether or not the 15% preference will be applied to this bid.

2. I \_\_\_\_\_, representative for \_\_\_\_\_, have read the requirements of the law cited above, and do not wish to apply for the Local Procurement Preference for Bid No.: GPA \_\_\_\_\_.

\_\_\_\_\_  
 Bidder Representative Signature

\_\_\_\_\_  
 Date

**NOTE:**  
 Prospective Bidders not completing this form will automatically be not considered for Local Procurement Preference. Non-completion of this form is not a basis for rejection of the bid or proposal.

**GOVERNMENT OF GUAM**  
**GENERAL TERMS AND CONDITIONS**  
**SEALED BID SOLICITATION AND AWARD**

**Only those Boxes checked below are applicable to this bid.**

1. **AUTHORITY:** This solicitation is issued subject to all the provision of the Guam Procurement Act (5GCA, Chapter 5) And the Guam Procurement Regulations (copies of both are available at the Office of the Complier of laws, Department of Law, copies available for inspection at the Guam Power Authority). It requires all parties involved in the Preparation, negotiation, performance, or administration of contracts to act in good faith.
2. **GENERAL INTENTION:** Unless otherwise specified, it is the declared and acknowledged intention and meaning of these General Terms and conditions for the bidder to provide the Government of Guam (Government) with specified services or with materials, supplies or equipment completely assembled and ready for use.
3. **TAXES:** Bidders are cautioned that they are subject to Guam Income Taxes as well as all other taxes on Guam Transactions. Specific information on taxes may be obtained from the Director of Revenue and Taxation.
4. **LICENSING:** Bidders are cautioned that the Government will not consider for award any offer submitted by a bidder who has not complied with the Guam Licensing Law. Specific information on licenses may be obtained from the Director of Revenue and Taxation.
5. **LOCAL PROCUREMENT PREFERENCE:** All procurement of supplies and services where possible, will be made from among businesses licensed to do business on Guam in accordance with section 5008 of the Guam Procurement Act (5GCA, Chapter 5) and Section 1-104 of the Guam Procurement Regulations.
6. **COMPLIANCE WITH SPECIFICATIONS AND OTHER SOLICITATION REQUIREMENTS:** Bidders shall comply with all specifications and other requirements of the Solicitation.
7. **"ALL OR NONE" BIDS:** Unless otherwise allowed under this Solicitation, "all or none" bids may be deemed to be non-responsive. If the bid is so limited, the Government may reject part of such proposal and award on the remainder.

**NOTE:** By checking this item, the Government is requesting all of the bid items to be bided or none at all. The Government will not award on an itemized basis. Reference: Section 3-101.06 of the Guam Procurement Regulations.

8. **INDEPENDENT PRICE DETERMINATION:** The bidder, upon signing the Invitation for Bid, certifies that the prices in his bid were derived at without collusion, and acknowledge that collusion and anti-competitive practices are prohibited by law. Violations will be subject to the provision of Section 5651 of that of the Guam Procurement Act. Other existing civil, criminal or administrative remedies are not impaired and may be in addition to the remedies in Section 5651 of the Government code.
9. **BIDDER'S PRICE:** The Government will consider not more than two (2) (Basic and Alternate) item prices and the bidder shall explain fully each price if supplies, materials, equipment, and/or specified services offered comply with specifications and the products origin. Where basic or alternate bid meets the minimum required specification, cost and other factors will be considered. Failure to explain this requirement will result in rejection of the bid.
10. **BID ENVELOPE:** Envelope shall be sealed and marked with the bidder's name, Bid number, time, date and place of Bid Opening.
11. **BID GUARANTEE REQUIREMENT:** Bidder is required to submit a Bid Guarantee Bond or standby irrevocable Letter of Credit or Certified Check or Cashier's Check in the same bid envelope to be held by the Government pending award. The Bid Guarantee Bond, Letter of Credit, Certified Check or Cashier's Check must be issued by any local surety or banking institution licensed to do business on Guam and made payable to the Guam Power Authority in the amount of fifteen percent (15%) of his highest total bid offer. The Bid Bond must be submitted on Government Standard Form BB-1 (copy enclosed). Personal Checks will not be accepted as Bid Guarantee. If a successful Bidder (contractor) withdraws from the bid or fails to enter into contract within the prescribed time, such Bid guarantee will be forfeited to the Government of Guam. Bids will be disqualified if not accompanied by Bid Bond, Letter of Credit, Certified Check or Cashier's check. Bidder must include in his/her bid, valid copies of a Power of Attorney from the Surety and a Certificate of Authority from the Government of Guam to show proof that the surety company named on the bond instrument is authorized by the Government of Guam and qualified to do business on Guam. For detailed information on bonding matters, contact the Department of Revenue and Taxation. Failure to submit a valid Power of Attorney and Certificate of Authority on the surety is cause for rejection of bid. (GPR Section 3-202.03.3) Pursuant to Public Law 27-127, all competitive sealed bidding for the procurement of supplies or services exceeding \$25,000.00 a 15% Bid Security of the total bid price must accompany the bid package.
12. **PERFORMANCE BOND REQUIREMENT:** The Bidder may be required to furnish a Performance Bond on Government Standard Form BB-1 or standby irrevocable Letter of Credit or Certified Check or Cashier's Check payable to the Guam Power Authority issued by any of the local Banks or Bonding Institution in the amount equal to Fifteen Percent (15%) of the contract prices as security for the faithful performance and proper fulfillment of the contract. In the event that any of the provisions of this contract are violated by the contractor, the Chief Procurement

Officer shall serve written notice upon both the contractor and the Surety of its intention to terminate the contract. Unless satisfactory arrangement or correction is made within ten (10) days of such notice the contract shall cease and terminate upon the expiration of the ten (10) days. In the event of any such termination, the Chief Procurement Officer shall immediately serve notice thereof upon the Surety. The Surety shall have the right to take over and perform the contract, provided, however, that if the Surety does not commence performance thereof within 10 days from the date of the mailing of notice of termination, the Government may take over and prosecute the same to complete the contract or force account for the account and at the expense of the contractor, and the contractor and his Surety shall be liable to the Government for any excess cost occasioned the Government thereby (GPR Section 3-202.03.4).

- [X] 13. **PERFORMANCE GUARANTEE:** Bidders who are awarded a contract under this solicitation, guarantee that goods will be delivered or required services performed within the time specified. Failure to perform the contract in a satisfactory manner may be cause for suspension or debarment from doing business with the Government and to enforce Section 23 of these General Terms and Conditions. In addition, the Government will hold the Vendor liable and will enforce the requirements as set forth in Section 41 of these General Terms and Conditions.
- [X] 14. **SURETY BONDS:** Bid and Performance Bonds coverage must be signed or countersigned in Guam by a foreign or alien surety's resident general agent. The surety must be an Insurance Company, authorized by the government of Guam and qualified to do business in Guam. Bids will be disqualified if the Surety Company does not have a valid Certificate of Authority from the Government of Guam to conduct business in Guam.
- [X] 15. **COMPETENCY OF BIDDERS:** Bids will be considered only from the such bidders who, in the opinion of the Government, can show evidence of their ability, experience, equipment, and facilities to render satisfactory service.
- [X] 16. **DETERMINATION OF RESPONSIBILITY OF BIDDERS:** The Chief Procurement Officer reserves the right for securing from bidders information to determine whether or not they are responsible and to inspect plant site, place of business; and supplies and services as necessary to determine their responsibility in accordance with Section 15 of these General Terms and Conditions (GPR Section 3-401).
- [X] 17. **STANDARD FOR DETERMINATION OF LOWEST RESPONSIBLE BIDDER:** In determining the lowest responsible offer, the Chief Procurement Officer shall be guided by the following:
- a) Price of items offered.
  - b) The ability, capacity, and skill of the Bidder to perform.
  - c) Whether the Bidder can perform promptly or within the specified time.
  - d) The quality of performance of the Bidder with regards to awards previously made to him.
  - e) The previous and existing compliance by the Bidder with laws and regulations relative to procurement.
  - f) The sufficiency of the financial resources and ability of the Bidder to perform.
  - g) The ability of the bidder to provide future maintenance and services for the subject of the award.
  - h) The compliance with all of the conditions to the Solicitation.
- [X] 18. **TIE BIDS:** If the bids are for the same unit price or total amount in the whole or in part, the Chief Procurement Officer will determine award based on Section 3.202.15.2, or to reject all such bids (GPR Section 3-202.15.2).
- [ ] 19. **BRAND NAMES:** Any reference in the Solicitation to manufacturer's Brand Names and number is due to lack of a satisfactory specification of commodity description. Such preference is intended to be descriptive, but not restrictive and for the sole purpose of indicating prospective bidders a description of the article or services that will be satisfactory. Bids on comparable items will be considered provided the bidder clearly states in his bid the exact articles he is offering and how it differs from the original specification.
- [X] 20. **DESCRIPTIVE LITERATURE:** Descriptive literature(s) as specified in this solicitation must be furnished as a part of the bid and must be received at the date and time set for opening Bids. The literature furnished must clearly identify the item(s) in the Bid. The descriptive literature is required to establish, for the purpose of evaluation and award, details of the product(s) the bidder proposes to furnish including design, materials, components, performance characteristics, methods of manufacture, construction, assembly or other characteristics which are considered appropriate. Rejection of the Bid will be required if the descriptive literature(s) do not show that the product(s) offered conform(s) to the specifications and other requirements of this solicitation. Failure to furnish the descriptive literature(s) by the time specified in the Solicitation will require rejection of the bid.
- [ ] 21. **SAMPLES:** Sample(s) of item(s) as specified in this solicitation must be furnished as a part of the bid and must be received at the date and time set for opening Bids. The sample(s) should represent exactly what the bidder proposes to furnish and will be used to determine if the item(s) offered complies with the specifications. Rejection of the Bid will be required if the sample(s) do not show that the product(s) offered conform(s) to the specifications and other requirements of this solicitation. Failure to furnish the sample(s) by the time specified in the Solicitation will require rejection of the Bid.
- [ ] 22. **LABORATORY TEST:** Successful bidder is required to accompany delivery of his goods with a Laboratory Test Report indicating that the product he is furnishing the Government meets with the specifications. This report is on the bidder's account and must be from a certified Testing Association.
- [X] 23. **AWARD, CANCELLATION, & REJECTION:** Award shall be made to the lowest responsible and responsive bidder, whose bid is determined to be the most advantageous to the Government, taking into consideration the evaluation factors set forth in this solicitation. No other factors or criteria shall be used in the evaluation. The right is reserved as the interest of the Government may require to waive any minor irregularity in bid received. The Chief Procurement Officer shall have the authority to award, cancel, or reject bids, in whole or in part for any one or more items if he determines it is in the public interest. Award issued to the lowest responsible bidder within the specified time for acceptance as indicated in the solicitation, results in a bidding contract without further action by either party. In case of an error in the extension of prices, unit price will govern. It is the policy of the Government to award contracts to qualified local bidders. The government reserves the right to increase or decrease the quantity of the items for award and make additional awards for the same type items and the vendor

agrees to such modifications and additional awards based on the bid prices for a period of thirty (30) days after original award. No award shall be made under this solicitation which shall require advance payment or irrevocable letter of credit from the government (GPR Section 3-202.14.1).

- [X] 24. **MARKING:** Each outside container shall be marked with the Purchase Order number, item number, brief item description and quantity. Letter marking shall not be less than 3/4" in height.
- [X] 25. **SCHEDULE FOR DELIVERY:** Successful bidder shall notify the Guam Power Authority, least twenty-four (24) hours before delivery of any item under this solicitation.
- [X] 26. **BILL OF SALE:** Successful supplier shall render Bill of Sale for each item delivered under this contract. Failure to comply with this requirement will result in rejection of delivery. The Bill of Sale must accompany the items delivered but will not be considered as an invoice for payment. Supplier shall bill the Government in accordance with billing instructions as indicated on the Purchase Order.
- [X] 27. **MANUFACTURER'S CERTIFICATE:** Successful bidder is required, upon delivery of any item under this contract, to furnish a certificate from the manufacturer indicating that the goods meet the specifications. Failure to comply with this request will result in rejection of delivery payment. Supplier shall bill the Government in accordance with billing instructions as indicated on the Purchase Order.
- [X] 28. **INSPECTION:** All supplies, materials, equipment, or services delivered under this contract shall be subject to the inspection and/or test conducted by the Government at destination. If in any case the supplies, materials, equipment, or services are found to be defective in material, workmanship, performance, or otherwise do not conform with the specifications, the Government shall have the right to reject the items or require that they be corrected. The number of days required for correction will be determined by the Government.
- [ ] 29. **MOTOR VEHICLE SAFETY REQUIREMENTS:** The Government will only consider Bids on motor vehicles which comply with the requirements of the National Traffic and Motor Vehicle safety Act of 1966 (Public Law 89-563) and Clean Air Act as amended (Public Law 88-206), that are applicable to Guam. Bidders shall state if the equipment offered comply with these aforementioned Federal Laws.
- [ ] 30. **SAFETY INSPECTION:** All motor vehicles delivered under this contract must pass the Government of Guam Vehicle Inspection before delivery at destination.
- [X] 31. **GUARANTEE:**  
 a) **Guarantee of Vehicle Type of Equipment:**  
 The successful bidder shall guarantee vehicular type of equipment offered against defective parts, workmanship, and performance, for a period of not less than one (1) year after date of receipt of equipment. Bidder shall also provide service to the equipment for at least one (1) year. Service to be provided shall include, but will not be limited to tune ups (change of spark plugs, contact points and condensers) and lubrication (change of engine and transmission oil). All parts and labor shall be at the expense of the bidder. All parts found defective and not caused by misuse, negligence or accident within the guarantee period shall be repaired, replaced, or adjusted within six (6) working days after notice from the Government and without cost to the Government. Vehicular type of equipment as used in this context shall include equipment used for transportation as differentiated from tractors, backhoes, etc.  
 b) **Guarantee of Other Type of Equipment:**  
 The successful bidder shall guarantee all other types of equipment offered, except those mentioned in 31a, above, against defective parts, workmanship, and performance for a period of not less than three (3) months after date of receipt of equipment. Bidder shall also provide service to the equipment for at least three (3) months. All parts found defective within that period shall be repaired or replaced by the Contractor without cost to the Government. Repairs, adjustments or replacements of defective parts shall be completed by the contractor within six (6) working days after notice from the Government.  
 c) **Compliance with this Section is a condition of this Bid.**
- [X] 32. **REPRESENTATION REGARDING ETHICS IN PUBLIC PROCUREMENT:** The bidder or contractor represents that it has not knowingly influenced and promises that it will not knowingly influence a Government employee to breach any of the ethical standards and represents that it has not violated, is not violating, and promises that it will not violate the prohibition against gratuities and kickbacks set forth on Chapter 11 (Ethics in Public Contracting) of the Guam Procurement Act and in Chapter 11 of the Guam Procurement Regulations.
- [X] 33. **REPRESENTATION REGARDING CONTINGENT FEES:** The contractor represents that it has not retained a person to solicit or secure a Government contract upon an agreement or understanding for a commission, percentage, brokerage, or contingent fee, except for retention of bona fide employees or bona fide established commercial selling agencies for the purpose of securing business (GPR Section 11-207).
- [X] 34. **EQUAL EMPLOYMENT OPPORTUNITY:** Contractors shall not discriminate against any employee or applicant of employment because of race, color, religion, sex, or national origin. The contractor will take affirmative action to ensure that employees are treated equally during employment without regards to their race, color, religion, sex, or national origin.
- [X] 35. **COMPLIANCE WITH LAWS:** Bidders awarded a contract under this Solicitation shall comply with the applicable standard, provisions, and stipulations of all pertinent Federal and/or local laws, rules, and regulations relative to the performance of this contract and the furnishing of goods.
- [ ] 36. **CHANGE ORDER:** Any order issued relative to awards made under this solicitation will be subject to and in accordance with the provisions of Section 6-101-03.1 of the Guam Procurement Regulations.
- [ ] 37. **STOP WORK ORDER:** Any stop work order issued relative to awards made under this solicitation

will be subject to and in accordance with the provisions of Section 6-101-04.1 of the Guam Procurement Regulations.

- [X] 38. **TERMINATION FOR CONVENIENCE:** Any termination order for the convenience of the Government issued relative towards made under this solicitation will be subject to and in accordance with the provisions of Section 6-101.10 of the Government Procurement Regulations.
  
- [X] 39. **TIME FOR COMPLETION:** It is hereby understood and mutually agreed by and between the contractor and the Government that the time for delivery to final destination or the timely performance of certain services is an essential condition of this contract. If the contractor refuses or fails to perform any of the provisions of this contract within the time specified in the Purchase Order (from the date Purchase Order is acknowledged by vendor), then the contractor is in default. Defaults will be treated subject to and in accordance with the provisions of Section 6-101-08 of the Guam Procurement Regulations.
  
- [X] 40. **JUSTIFICATION OF DELAY:** Bidders who are awarded contracts under this Solicitation, guarantee that the goods will be delivered to their destination or required services rendered within the time specified. If the bidder is not able to meet the specified delivery date, he is required to notify the Chief Procurement Officer of such delay. Notification shall be in writing and shall be received by the Chief Procurement Officer at least twenty-four (24) hours before the specified delivery date. Notification of delay shall include an explanation of the causes and reasons for the delay including statement(s) from supplier or shipping company causing the delay. The Government reserves the right to reject delay justification if, in the opinion of the Chief Procurement Officer, such justification is not adequate.
  
- [X] 41. **LIQUIDATED DAMAGES:** When the contractor is given notice of delay or nonperformance as specified in Paragraph 1 (Default) of the Termination for Default Clause of this contract and fails to cure in the time specified, the contractor shall be liable for damages for delay in the amount of one-fourth of one percent (1%) of outstanding order per calendar day from date set for cure until either the territory reasonable obtains similar supplies or services if the contractor is terminated for default, or until the contractor provides the supplies or services if the contractor is not terminated for default. To the extent that the contractor's delay or nonperformance is excused under Paragraph 40 (Excuse for Nonperformance or Delayed Performance) of the Termination for Default Clause of this contract, liquidated damages shall not be due the territory. The contractor remains liable for damages caused other than by delay (GPR Section 6-101-09.1).
  
- [X] 42. **PHYSICAL LIABILITY:** If it becomes necessary for the Vendor, either as principal, agent or employee, to enter upon the premises or property of the Government of Guam in order to construct, erect, inspect, make delivery or remove property hereunder, the Vendor hereby covenants and agrees to take, use, provide and make all proper, necessary and sufficient precautions, safeguards and protections against the occurrence of any accidents, injuries or damages to any person or property during the progress of the work herein covered, and to be responsible for, and to indemnify and save harmless the Government of Guam from the payment of all sums of money by reason of all or any such accidents, injuries or damages that may occur upon or about such work, and fines, penalties and loss incurred for or by reasons of the violations of any territorial ordinance, regulations, or the laws of Guam or the United States, while the work is in progress. Contractor will carry insurance to indemnify the Government of Guam against any claim for loss, damage or injury to property or persons arising out of the performance of the Contractor or his employees and agents of the services covered by the contract and the use, misuse or failure of any equipment used by the contractor or his employees or agents, and shall provide certificates of such insurance to the Government of Guam when required.
  
- [X] 43. **CONTACT FOR CONTRACT ADMINISTRATION:** If your firm receives a contract as a result of this Solicitation, please designate a person whom we may contact for prompt administration.

Name: \_\_\_\_\_ Title: \_\_\_\_\_  
 Address: \_\_\_\_\_ Telephone: \_\_\_\_\_  
 \_\_\_\_\_  
 \_\_\_\_\_

**GOVERNMENT OF GUAM**

**SEALED BID SOLICITATION INSTRUCTIONS**

1. **BID FORMS:** Each bidder shall be provided with two (2) sets of Solicitation forms. Additional copies may be provided upon request. Bidders requesting additional copies of said forms will be charged per page in accordance with Section 6114 of the Government Code of Guam. All payments for this purpose shall be by cash, certified check or money order and shall be made payable to the Guam Power Authority.
2. **PREPARATIONS OF BIDS:**
  - a) Bidders are required to examine the drawings, specifications, schedule, and all instructions. Failure to do so will be at bidder's risk.
  - b) Each bidder shall furnish the information required by the Solicitation. The bidder shall sign the solicitation and print or type his name on the Schedule. Erasures or other changes must be initialed by the person signing the bid. Bids signed by an agent are to be accompanied by evidence of this authority unless such evidence has been previously furnished to the issuing office.
  - c) Unit price for each unit offered shall be shown and such price shall include packing unless otherwise specified. A total shall be entered in the amount column of the Schedule for each item offered. In case of discrepancies between a unit price and extended price, the unit price will be presumed to be correct.
  - d) Bids for supplies or services other than those specified will not be considered. Time, if stated as a number of days, means calendar days and will include Saturdays, Sundays, and holidays beginning the day after the issuance of a Notice to Proceed. Time stated ending on a Saturday, Sunday or Government of Guam legal holiday will end at the close of the next business day.
3. **EXPLANATION TO BIDDERS:** Any explanation desired by a bidder regarding the meaning or interpretation of the Solicitation, drawings, specifications, etc., must be submitted in writing and with sufficient time allowed for a written reply to reach all bidders before the submission of their bids. Oral explanations or instructions given before the award of the contract will not be binding. Any information given to a prospective bidder concerning a Solicitation will be furnished to all prospective bidders in writing as an amendment to the Solicitation if such information would be prejudicial to uninformed bidders.
4. **ACKNOWLEDGEMENT OF AMENDMENTS TO SOLICITATIONS:** Receipt of an amendment to a Solicitation by a bidder must be acknowledged by signing an acknowledgement of receipt of the amendment. Such acknowledgement must be received prior to the hour and date specified for receipt of bids.
5. **SUBMISSION OF BIDS:**
  - a) Bids and modifications thereof shall be enclosed in sealed envelopes and addressed to the office specified in the Solicitation. The bidder shall show the hour and date specified in the Solicitation for receipt, the Solicitation number, and the name and address of the bidder on the face of the envelope.
  - b) Telegraphic bids will not be considered unless authorized by the Solicitation. However, bids may be modified or withdrawn by written or telegraphic notice, provided such notice is received prior to the hour and date specified for receipt (see paragraph 6 of these instructions).
  - c) Samples of items, when required, must be submitted within the time specified, unless otherwise specified by the Government, at no expense to the Government. If not destroyed by testing, samples will be returned at bidder's request and expense, unless otherwise specified by the Solicitation.
  - d) Samples or descriptive literature should not be submitted unless it is required on this solicitation. Regardless of any attempt by a bidder to condition the bid, unsolicited samples or descriptive literature will not be examined or tested at the bidder's risk, and will not be deemed to vary any of the provisions of this Solicitation.
6. **FAILURE TO SUBMIT BID:** If no bid is to be submitted, do not return the solicitation unless otherwise specified. A letter or postcard shall be sent to the issuing office advising whether future Solicitations for the type of supplies or services covered by this Solicitation are desired.
7. **LATE BID, LATE WITHDRAWALS, AND LATE MODIFICATIONS:**
  - a) Definition: Any bid received after the time and date set for receipt of bids is late. Any withdrawal or modification of a bid received after the time and date set for opening of bids at the place designated for opening is late (Guam Procurement Regulations Section 3-202)
  - b) Treatment: No late bid, late modification, or late withdrawal will be considered unless received before contract award, and the bid, modification, or withdrawal would have been timely but for the action or inaction of territorial personnel directly serving the procurement activity.
8. **DISCOUNTS:**
  - a) Notwithstanding the fact that prompt payment discounts may be offered, such offer will not be considered in evaluating bids for award unless otherwise specified in the Solicitation. However, offered discounts will be taken if payment is made within the discount period, even though not considered in the evaluation of bids.
  - b) In connection with any discount offered, time will be computed from date of delivery and acceptance of the supplies to the destination as indicated in the purchase order or contract. Payment is deemed to be made for the purpose of earning the discount on the date of mailing of the Government check.



9. **GOVERNMENT FURNISHED PROPERTY:** No material, labor or facilities will be furnished by the Government unless otherwise provided for in the Solicitation.
10. **SELLERS' INVOICES:** Invoices shall be prepared and submitted in quadruplicate (one copy shall be marked "original") unless otherwise specified. Invoices shall be "certified true and correct" and shall contain the following information: Contract and order number (if any), item numbers, description of supplies or services, sizes, quantities, unit prices, and extended total. Bill of lading number and weight of shipment will be shown for shipments made on Government bills of lading.
11. **RECEIPT, OPENING AND RECORDING OF BIDS:** Bids and modifications shall be publicly opened in the presence of one or more witnesses, at the time, date, and place designated in the Invitation for Bids. The name of each bidder, the bid price, and such other information as is deemed appropriate by the Procurement Officer, shall be read aloud and recorded, or otherwise made available. The names and addresses of required witnesses shall be recorded at the opening. The opened bids shall be available for public inspection except to the extent the bidder designates trade secrets or other proprietary data to be confidential as set forth in accordance with Section 12 below. Material so designated shall accompany the bid and shall be readily separable from the bid in order to facilitate public inspection of the non-confidential portion of the bid. Prices, makes and models or catalogue numbers of the items offered, deliveries, and terms of payment shall be publicly available at the time of bid opening regardless of any designation to the contrary (Guam Procurement Regulations Section 3-202.12.2).
12. **CONFIDENTIAL DATA:** The Procurement Officer shall examine the bids to determine the validity of any requests for nondisclosure of trade secrets and other proprietary data identified in writing. If the parties do not agree as to the disclosure of data, the Procurement Officer shall inform the bidders in writing what portions of the bid will be disclosed and that, unless the bidders protest under Chapter 9 of the Guam Procurement Act (P.L. 16-124), the bids will be so disclosed. The bids shall be opened to public inspection subject to any continuing prohibition on the disclosure of confidential data (Guam Procurement Regulations Section 3-202.12.3).
13. **MULTI-STEP SEALED BIDDING:**
- a. It is defined as two-phase process consisting of a technical first-phase composed of one or more steps in which bidders submit unpriced technical offers to be evaluated by the territory, and a second-phase in which those bidders whose technical offers are determined to be acceptable during the first-step have their priced bids considered. It is designed to obtain the benefits of competitive sealed bidding by award of a contract to the lowest responsive, responsible bidder, and at the same time obtained the benefits of the competitive sealed proposals procedure through the solicitation of technical offers and the conduct of discussions to evaluate and determine the acceptability of technical offers.
  - b. In addition to the requirements set forth in the General Terms and Conditions and the Special provisions, the following applies:
    - 1). only unpriced technical offers are requested in the first phase;
    - 2). priced bids will be considered only in the second phase and only from bidders whose unpriced technical offers are found acceptable in the first phase;
    - 3). the criteria to be used in the evaluation at those specified in the Special Provisions and the General Terms and Conditions;
    - 4). the territory, to the extent the Procurement Officer finds necessary, may conduct oral or written discussion of the unpriced technical offers;
    - 5). the bidders, may designate those portions of the unpriced technical offers which contain trade secrets or other proprietary data which are to remain confidential; and,
    - 6). the service being procured shall be furnished generally in accordance with bidder's technical offer as found to be finally acceptable and shall meet the requirements of the Invitation for Bids.
  - c. **RECEIPT AND HANDLING OF UNPRICED TECHNICAL OFFERS.**  
Unpriced technical offers shall not be opened publicly, but shall be opened in front of two or more procurement officials. Such offers shall not be disclosed to unauthorized persons. Bidders may request nondisclosure of trade secrets and other proprietary data identified in writing.
  - d. **EVALUATION OF UNPRICED TECHNICAL OFFERS.**  
The unpriced technical offers submitted by bidders shall be evaluated solely in accordance with the criteria set forth in the Invitation for Bids. The unpriced technical offers shall be categorized as:
    - 1). acceptable;
    - 2). potentially acceptable, that is, reasonably susceptible of being made acceptable; or
    - 3). unacceptable. The Procurement Officer shall record in writing the basis for finding an offer unacceptable and make it part of the procurement file.

The Procurement Officer may initiate Phase Two of the procedure if, in the Procurement Officer's opinion, there are sufficient acceptable unpriced technical offers to assure effective price competition in the second phase without technical discussions. If the Procurement Officer finds such is not the case, the Procurement Officer shall issue an amendment to the Invitation for Bids or engage in technical discussions as set forth in Subsection 3-202.20.5 of this Section.
  - e. Upon the completion of Phase One, the Procurement Officer shall invite each acceptable bidder to submit a price bid. Upon submission of prices, the Procurement Officer shall prepare the final evaluation and reconsideration for the Chief Procurement Officer's approval.