



JOSEPH T. DUENAS
Chairman



JOHN M. BENAVENTE, P.E.
General Manager

Telephone Nos. (671) 648-3054/55 or Facsimile (671) 648-3165

Accountability · Impartiality · Competence · Openness · Value

INVITATION FOR BID (IFB) NO.: GPA-079-19
DESCRIPTION: Pole Mounted Transformers

SPECIAL REMINDERS TO PROSPECTIVE BIDDERS

Bidders are reminded to read the Sealed Bid Solicitation and Instructions, and General Terms and Conditions attached to the IFB to ascertain that all of the following requirements checked below are submitted in the bid envelope, one (1) original and two (2) copies, at the date and time for bid opening.

- (XX) BID GUARANTEE (15%) May be in the form of;
Reference #11 on the General Terms and Conditions
 - a. Cashier's Check or Certified Check (NOTE: Cashier's Check or Certified Check Refunds will be ONLY be made out to the name of the Bidder.)
 - b. Letter of Credit or
 - c. Surety Bond – Valid only if accompanied by:
 - 1. Current Certificate of Authority issued by the Insurance Commissioner;
 - 2. Power of Attorney issued by the Surety to the Resident General Agent;
 - 3. Power of Attorney issued by two (2) major officers of the Surety to whomever is signing on their behalf.

() STATEMENT OF QUALIFICATION;

() SAMPLES;

(XX) BROCHURES/DESCRIPTIVE LITERATURE; (Shall provide detailed literature on items offered)

(XX) AFFIDAVIT OF DISCLOSURE OF MAJOR SHAREHOLDERS;

(XX) NON-COLLUSION AFFIDAVIT;

(XX) NO GRATUITIES OR KICKBACKS AFFIDAVIT;

(XX) ETHICAL STANDARDS AFFIDAVIT;

(XX) WAGE DETERMINATION AFFIDAVIT;

(XX) RESTRICTIONS AGAINST SEX OFFENDERS AFFIDAVIT;

Note: The above Affidavits must comply with the following requirements:

- a. The affidavit must be signed within 60 days of the date the bid is due;
- b. Date of signature of the person authorized to sign the bid and the notary date must be the same.
- c. First time affidavit must be an original – If copy, indicate Bid Number/Agency where original can be obtained.

(XX) OTHER REQUIREMENTS:

A Guam Business License and/or Contractor's License with proof of Employer Identification Number (EIN) is not required in order to provide a proposal for this engagement, but is a pre-condition for entering into a contract with the Authority. Bidders MUST comply with PL 26-111 dated June 18, 2002, PL 28-165 dated January 04, 2007 and Wage Determination under the Service Contract Act (www.wdol.gov). Additionally, upon award the successful bidder must provide to GPA the most recently issued Wage Determination by the US Dept. of Labor.

The reminder must be signed and returned in the bid envelope together with the bid. Failure to comply with the above requirements will mean a disqualification and rejection of the bid.

On this _____ day of _____ 2019, I, _____, authorized representative of _____ acknowledge receipt of this special reminder to prospective bidders with the above referenced IFB.

Bidder Representative's Signature

INVITATION FOR BID

ISSUING OFFICE:
Guam Power Authority
Procurement Management Materials Supply
Gloria B. Nelson Public Service Building
688 Route 15, Mangilao, Guam 96913

 7/29/19
JOHN M. BENAVENTE, P.E. DATE
General Manager

DATE ISSUED: 07/30/2019 & 08/06/2019 BID INVITATION NO.: GPA-079-19
BID FOR: Pole Mounted Transformers
SPECIFICATION: See Attached
DESTINATION: See Attached
REQUIRED DELIVERY DATE: 12 Weeks After Receipt of Order (ARO)

INSTRUCTIONS TO BIDDERS:
INDICATE WHETHER: INDIVIDUAL PARTNERSHIP CORPORATION
INCORPORATED IN: _____

This bid shall be submitted in duplicate and sealed to the issuing office above no later than (Time) 2:00 P.M., Date: 08/14/2019 and shall be publicly opened. Bid submitted after the time and date specified above shall be rejected. See attached General Terms and Conditions and Sealed Bid Solicitation for details.

The undersigned offers and agrees to furnish within the time specified, the articles and services at the price stated opposite the respective items listed on the schedule provided, unless otherwise specified by the bidder. In consideration to the expense of the Government in opening, tabulating, and evaluating this and other bids, and other considerations, the undersigned agrees that this bid remain firm and irrevocable within one hundred twenty (120) calendar days from the date opening to supply any or all of the items which prices are quoted.

NAME AND ADDRESS OF BIDDER: _____ SIGNATURE AND TITLE OF PERSON AUTHORIZED TO SIGN THIS BID: _____

AWARD: CONTRACT NO.: _____ AMOUNT: _____ DATE: _____

ITEM NO(S). AWARDED: _____

CONTRACTING OFFICER:
JOHN M. BENAVENTE, P.E. DATE
General Manager

NAME AND ADDRESS OF CONTRACTOR: _____ SIGNATURE AND TITLE OF PERSON _____

INVITATION FOR BID NO.: GPA-079-19

Requisition No.: 33200

NO.	DESCRIPTION	QTY.	U/I	U/P:	T/P:
-----	-------------	------	-----	------	------

1.0 100 kVA Pole Mounted Transformers 10 Each \$ _____ \$ _____

COMPLY / NON-COMPLIANCE:

A. SPECIFICATIONS:

- A.1- Single-Phase, Insulation Class 15 kV, BIL 95 kV, Primary Voltage 13.8 kV, Secondary Voltage 120/240 V. without lightning arresters.
- A.2- The tank, cover and cover band shall be made of type 304L stainless steel.
- A.3- To include mounting bolts for lightning arresters, grounding straps and grounding lugs.

As per GPA Specifications No.: E-012, Revision 10
GPA Index No.: E012010013802040S

COMPLY / NON-COMPLIANCE:

B. SAFETY DATA SHEET (SDS):

- B.1- Provide consignee with 'SAFETY DATA SHEET' when making deliveries to avoid rejection.

C. LOSS EVALUATION:

- C.1- Bid award for pole mounted transformers shall be based on the Total Cost of Ownership (TCO) and all other requirements as specified in GPA Specification E-012, Revision 10, Section 6.3.

COMPLY / NON-COMPLIANCE:

D. MARKING REQUIREMENTS:

- D.1- Stencil 1" GPA Index No./Purchase Order No./Bid No./Serial No. and Date of MFG. (DO NOT OBLITERATE MFG LABEL)
- D.2- Manufacturer Serial No. shall be shown on all delivery receipts and invoices.
- D.3- All transformers shall have a weather resistant decal certifying NON-PCB.
- D.4- Vendors are to provide a user's manual and certified laboratory test report for every transformer delivered.
- D.5- Vendors are responsible to de-van materials from containers.
- D.6- Vendors are responsible to provide a means to off load transformers that are 750 kVA or larger.
- D.7- Transformers shall meet all United States Department of Energy requirements.

NOTE:

Notwithstanding the fact that this contract was written by one (1) party, it will be construed that it was written by two (2) parties.

All deviations shall be identified referencing the Section and Sub-Section(s) from the attached GPA Specification.

DELIVERY REQUIREMENT:

12 Weeks After Receipt of Order (ARO)

REMARKS / DEVIATIONS:

Any delivery extension for this specific bid shall not be granted due to on-going and/or scheduled projects.

INVITATION FOR BID NO.: GPA-079-19

Requisition No.: 33200

NO.	DESCRIPTION	QTY.	U/I	U/P:	T/P:
-----	-------------	------	-----	------	------

TO BE COMPLETED BY BIDDER:

MANUFACTURED BY/BRAND NAME: _____

CAT. NO./PART NO.: _____

PLACE OF ORIGIN: _____

EXPORT ABROAD: _____

TIME OF DELIVERY AFTER RECEIPT OF PURCHASE ORDER: _____

Specifications Generated/Review By:

 7/29/19
 Reuben C. Ulloa Date
 Supervisor, Substation Electrician, T&D

Specifications Reviewed By:

 7.29.19
 Jamie Lynn C. Pangelinan Date
 Supply Management Administrator

Specifications Approved By:

 7/29/19
 Beatrice P. Limtiaco Date
 Assistant General Manager -
 Administration

INVITATION FOR BID NO.: GPA-079-19

Requisition No.: 33200

NO.	DESCRIPTION	QTY.	U/I	U/P:	T/P:
-----	-------------	------	-----	------	------

2.0 100 kVA Pole Mounted Transformers 3 Each \$ _____ \$ _____

COMPLY / NON-COMPLIANCE:

A. SPECIFICATIONS:

- A.1- Single-Phase, Insulation Class 15 kV, BIL 95 kV, Primary Voltage 13.8 kV, Secondary Voltage 240/480 V. without lightning arresters.
- A.2- The tank, cover and cover band shall be made of type 304L stainless steel.
- A.3- To include mounting bolts for lightning arresters, grounding straps and grounding lugs.

As per GPA Specifications No.: E-012, Revision 10
GPA Index No.: E012010013804048S

COMPLY / NON-COMPLIANCE:

B. SAFETY DATA SHEET (SDS):

- B.1- Provide consignee with 'SAFETY DATA SHEET' when making deliveries to avoid rejection.

C. LOSS EVALUATION:

- C.1- Bid award for pole mounted transformers shall be based on the Total Cost of Ownership (TCO) and all other requirements as specified in GPA Specification E-012, Revision 10, Section 6.3.

COMPLY / NON-COMPLIANCE:

D. MARKING REQUIREMENTS:

- D.1- Stencil 1" GPA Index No./Purchase Order No./Bid No./Serial No. and Date of MFG. (DO NOT OBLITERATE MFG LABEL)
- D.2- Manufacturer Serial No. shall be shown on all delivery receipts and invoices.
- D.3- All transformers shall have a weather resistant decal certifying NON-PCB.
- D.4- Vendors are to provide a user's manual and certified laboratory test report for every transformer delivered.
- D.5- Vendors are responsible to de-van materials from containers.
- D.6- Vendors are responsible to provide a means to off load transformers that are 750 kVA or larger.
- D.7- Transformers shall meet all United States Department of Energy requirements.

NOTE:

Notwithstanding the fact that this contract was written by one (1) party, it will be construed that it was written by two (2) parties.

All deviations shall be identified referencing the Section and Sub-Section(s) from the attached GPA Specification.

DELIVERY REQUIREMENT:

12 Weeks After Receipt of Order (ARO)

REMARKS / DEVIATIONS:

Any delivery extension for this specific bid shall not be granted due to on-going and/or scheduled projects.

INVITATION FOR BID NO.: GPA-079-19

Requisition No.: 33200

NO.	DESCRIPTION	QTY.	U/I	U/P:	T/P:
-----	-------------	------	-----	------	------

TO BE COMPLETED BY BIDDER:

MANUFACTURED BY/BRAND NAME: _____

CAT. NO./PART NO.: _____

PLACE OF ORIGIN: _____

EXPORT ABROAD: _____

TIME OF DELIVERY AFTER RECEIPT OF PURCHASE ORDER: _____

Specifications Generated/Review By:

 7/29/19

 Reuben C. Ulloa Date
 Supervisor, Substation Electrician, T&D

Specifications Reviewed By:

 7/29/19

 Jamie Lynn C. Pangelinan Date
 Supply Management Administrator

Specifications Approved By:

 7/29/19

 Beatrice P. Limtiaco Date
 Assistant General Manager -
 Administration



**GUAM POWER
AUTHORITY**

SPECIFICATION No. E-012

April 4, 2018

PREPARED BY THE ENGINEERING DEPARTMENT

REV. 10

**GUAM POWER AUTHORITY
P.O. BOX 2977
HAGATNA, GUAM 96932**

**TRANSMISSION & DISTRIBUTION SPECIFICATION
Specification No. E-012**

FOR

**SINGLE-PHASE POLE-MOUNTED
DISTRIBUTION TRANSFORMER**

EFFECTIVE DATE:

4/4/2018

ISSUED:

APPROVED:

 <p>GUAM POWER AUTHORITY</p>	<p>SPECIFICATION No. E-012</p>	<p>Page 2 of 13</p>
		<p>April 4, 2018</p>
<p>PREPARED BY THE ENGINEERING DEPARTMENT</p>		<p>REV. 10</p>

**SINGLE PHASE POLE MOUNTED
DISTRIBUTION TRANSFORMER**

TABLE OF CONTENTS

SECTION	PAGE
1.0 SCOPE.....	3
2.0 APPLICABLE PUBLICATIONS.....	3
3.0 DEVIATIONS AND NON-CONFORMANCE REQUIREMENTS.....	3
4.0 SUBMITTALS.....	4
5.0 CERTIFIED LABORATORY TEST REPORTS.....	5
6.0 LOSS EVALUATION.....	5
7.0 RATINGS.....	6
8.0 DESIGN.....	6
9.0 CONSTRUCTION.....	8
10.0 QUALITY CONTROL.....	10
11.0 PACKING AND SHIPPING.....	10

EFFECTIVE DATE: 4/4/2018	ISSUED: 	APPROVED: 
--------------------------	---	---



GUAM POWER
AUTHORITY

SPECIFICATION No. E-012

April 4, 2018

PREPARED BY THE ENGINEERING DEPARTMENT

REV. 10

1.0 SCOPE

- 1.1. This specification covers GPA requirements for single-phase, 60 Hz, mineral oil filled, self-cooled, self-protected, 65 degree C rise pole mounted type distribution transformers.
- 1.2. The transformer is intended for use in tropical weather conditions with a corrosive sea air atmosphere, sustained wind strengths of 155 MPH with 3 second gusts to 170 MPH and International Building Code 2009 Zone 4 seismic requirements shall apply.

2.0 APPLICABLE PUBLICATIONS

The transformers shall meet the requirements of the following standards, including the latest revisions with respect to material, design and tests.

- 2.1. AMERICAN NATIONAL STANDARDS INSTITUTE, INC. (ANSI)
 - C57 IEEE Standard for Overhead-Type Distribution Transformers 500 kVA and Smaller
 - C68.1 Techniques for Dielectric Tests
 - C76 Apparatus Bushings
 - 255.1 Gray Finishes for Industrial Apparatus and Equipment
- 2.2. NATIONAL ELECTRICAL MANUFACTURERS ASSOCIATION (NEMA) STANDARDS:
 - TR 1 Transformers, Regulators and Reactors
- 2.3. AMERICAN SOCIETY FOR TESTING AND MATERIALS (ASTM) STANDARD
 - D3487 Mineral Insulating Oil used in Electrical Apparatus
 - D92 Manual Cleveland Flashpoint Tester
 - D877 Dielectric Breakdown Voltage of Insulating Liquids
- 2.4. NATIONAL FIRE PROTECTION ASSOCIATION (NFPA)
 - 70 National Electrical Code
 - 70B Electrical Equipment Maintenance
- 2.5. US DEPARTMENT OF ENERGY (DOE)
 - 10 CFR Part 431 Subpart K - Distribution Transformers
- 2.6. National Electric Safety Code (NESC) Part 2: Safety Rules for Overhead Lines
 - Section 250 General Loading Requirements
- 2.7. International Building Code 2009

3.0 DEVIATIONS AND NON-CONFORMANCE REQUIREMENTS

- 3.1. Deviations from this specification or changes in the material or design after the purchase order has been placed must be approved by the GPA Engineering department and acknowledged by a Purchase Order Amendment issued by GPA.
- 3.2. Units received with deviations or non-conformances that are not acknowledged per Section 3.1 are subject to rejection. The Supplier of rejected units is responsible for any corrective

EFFECTIVE DATE: 4/4/2018

ISSUED: [Signature]

APPROVED: [Signature]



GUAM POWER
AUTHORITY

SPECIFICATION No. E-012

April 4, 2018

PREPARED BY THE ENGINEERING DEPARTMENT

REV. 10

action including but not limited to materials, labor and transportation necessary to dispose of or make the units conform to the specification.

- 3.3. Notification of defective units discovered before or after installation that are believed to be inherent to manufacturing problems or workmanship shall be made and forwarded to the Supplier. The description of the item, documentation of the problem and the described information, disposition and/or follow-up (as appropriate) that GPA expects from the Supplier will be specified. The Supplier's response shall be made within thirty (30) days unless an extension IS acknowledged and approved in writing by the GPA Manager of Engineering.
- 3.4. Warranty –the Supplier shall warrant the distribution transformer to be free from defects in material and workmanship under normal use and service conditions. The term of the Warranty shall be the lesser of twelve (12) months from the date of initial installation or eighteen (18) months from date of sale/purchase.
- 3.5. Statement of Compliance - The Supplier shall provide a signed statement verifying that the products being supplied fully comply with the specifications and drawings. Items not in full compliance with the specification and drawings will be identified with a description of the deficiency and any proposed substitutions. Items not in full compliance with the specifications and drawings must be approved by the GPA Engineering Department, as described in Section 3.1.

4.0 SUBMITTALS

- 4.1. The bidder shall provide with their bid the following data:
 - a. Nameplate Data
 - b. Connection diagrams
 - c. Guaranteed total loss at 100% voltage and load
 - d. Guaranteed no-load loss at rated voltage
 - e. Physical dimension drawings
 - f. Low voltage circuit breaker time-current characteristics curve
- 4.2. After award of contract, shop drawings indicating details of construction and the outline of all connectors shall be submitted to GPA Engineering for review and approval.
- 4.3. Information shall include:
 - a. Mounting dimensions
 - b. Location of equipment, devices and terminals
 - c. Weights
 - d. Number of gallons of oil
 - e. Nameplate Data
 - f. Connection diagrams
 - g. Guaranteed total loss at 100% voltage and load
 - h. Guaranteed no-load loss at rated voltage
- 4.4. GPA shall be allowed two (2) weeks to review and approve drawings provided in Section 4.2 without affecting the shipping date. Delays in delivery due to drawings that are disapproved during this review period are the responsibility of the Supplier.
- 4.5. Drawings returned to the Supplier as approved shall be considered authorization to proceed with the work. The approval of GPA shall in no way abrogate the requirements of this specification.

5.0 CERTIFIED LABORATORY TEST REPORTS

EFFECTIVE DATE: 4/4/2018	ISSUED: 	APPROVED: 
--------------------------	---	---

 GUAM POWER AUTHORITY	SPECIFICATION No. E-012	Page 5 of 13
		April 4, 2018
		REV. 10
PREPARED BY THE ENGINEERING DEPARTMENT		

- 5.1. Certified tests shall be conducted in accordance with ANSI C57 plus a standard production impulse test. Transformers shall have passed all required tests demonstrating compliance with the design requirements and industry standards.
- 5.2. The Supplier shall also conduct tests to determine transformer load and no-load losses. This test data shall be certified as true and correct by an independent testing firm and submitted to the Authority.
- 5.3. The Supplier shall furnish two (2) copies of the certified test reports of all tests covered by this specification to the GPA Manager of Engineering prior to shipment.

6.0 LOSS EVALUATION

- 6.1. Each bidder shall submit with his bid the guaranteed load and no-load losses on each transformer submitted. Guaranteed load losses shall be provided at 85° C and shall be stated at the nominal voltage tap positions.
- 6.2. Guaranteed losses will be evaluated by GPA to determine the equivalent cost for owning and operating each transformer. The value of the transformer no-load and load losses will be determined by GPA at the time of purchase to arrive at the projected Total Cost of Ownership (TCO) as follows:

$$TCO = IC + A \times (P_o + P_{co}) + B \times (P_k + P_{cs} - P_{co}) \text{ Where:}$$

- P_o = No Load Losses (NLL) in kW (Provided by Bidder)
 P_{co} = Power Consumption of Cooling Equipment at No Load Operation (Zero Power Consumption of Cooling Equipment, unless otherwise provided)
 P_k = Load Losses (LL) in kW (Provided by Bidder)
 P_{cs} = Power Consumption of Cooling Equipment at Rated Power Operation (Zero Power Consumption of Cooling Equipment, unless otherwise provided)
 IC = Initial Transformer Cost (Provided by Bidder)
 A = $t \times c_{n/2} \times (1 - (1 / (1 + i))^n) / i$
 B = $u \times t \times c_{n/2} \times (1 - (1 / (1 + i))^n) / i$
 u = k^2
 t = Operating Hours per Year (24 Hours/Day X 365 Days/Year = 8760 Hours)
 i = Discount Rate (5% Used By GPA for Money Certificates Issued)
 n = Expected Lifetime of the Transformer in Years (GPA Uses 25 Years)
 $c_{n/2}$ = Is the Cost of energy at the Mid-Life of the Transformer

Note: If Annual increase of energy price is assumed to be constant, $c_{n/2}$ can be calculated using C, j & n

- $c_{n/2}$ = $(C + (C \times (1 + j)^n)) / 2$
 C = Is the Initial Cost of Energy (\$) (Calculated From the weighted average energy rate from the Revenue Report with Fuel-Non Fuel Data Dec 2017)
 j = Is the Annual Increase of Energy Price (%) (Calculated from the Base Rate Increases from 1998 to 2018)
 k = Is the Average Loading of the Transformer During its Lifetime (Calculated using data From the GPA Distribution Analysis 2010-2015)

EFFECTIVE DATE: 4/4/2018

ISSUED: 

APPROVED: 



GUAM POWER
AUTHORITY

SPECIFICATION No. E-012

April 4, 2018

PREPARED BY THE ENGINEERING DEPARTMENT

REV. 10

- 6.3. A Band of Equivalence method will be used when evaluating the total cost for owning and operating each transformer. Transformers with a TOC that is within 5% of the transformer with the lowest TOC will be considered equivalent. The transformer with the lowest purchase price within this band shall be considered the lowest bid.
- 6.4. GPA will review actual, certified load and no-load losses for each transformer. In the event the actual losses exceed the guaranteed losses, the Supplier's contract will be reduced. The price reduction shall be the difference between the guaranteed losses and the actual losses at the rates indicated above. Load and no-load loss penalties will be assessed independently. Bonuses will not be awarded for actual losses which are less than guaranteed. Any transformer with no-load losses or total losses greater than the tolerances indicated in ANSI C57 shall be rejected by the Authority.

7.0 RATINGS

- 7.1. The primary voltage rating is 13,800 V.
- 7.2. Secondary Voltage ratings shall be either 120/240, 277, 240/480 volts as required.
- 7.3. The insulation class is 15 kV and the primary-voltage BIL is 95 kV. The secondary voltage BIL shall be 30 kV.
- 7.4. The required transformer kVA ratings will be indicated on the purchase order. The following kVA ratings are standard for GPA pole mounted transformers.
- 5, 10, 15, 25, 37.5, 50, 75, 100 and 167
- 7.5. The transformer impedance shall be as indicated in Table 1. ANSI tolerances may be applied to these values. The impedance value shall be provided on the nameplate.

TABLE 1
Transformer Impedance

Size (kVA)	Minimum Impedance (%)	Maximum Impedance (%)
5 - 37.5	1.0	4.5
50 - 167	1.5	4.5

- 7.6. The transformer shall meet the latest energy efficiency standards for liquid immersed distribution pole mounted transformers required by the United States Department of Energy.
- 7.7. The Average Winding Rise shall be 65°C.

8.0 DESIGN

- 8.1. Taps
- a. Unless otherwise specified, taps shall be furnished on the high voltage winding. Tap ratios shall conform to ANSI C57 for 13.8 kV transformers, with two 2½ % taps above and below the rated voltage.
- b. Taps shall be full KVA rated and have short circuit capability noted in ANSI C57.

EFFECTIVE DATE: 4/4/2018

ISSUED: [Signature]

APPROVED: [Signature]



GUAM POWER
AUTHORITY

SPECIFICATION No. E-012

April 4, 2018

PREPARED BY THE ENGINEERING DEPARTMENT

REV. 10

- c. The selection of the tap desired shall be obtained through the operation of an externally operated switch.
1. The switch shall be designed for de-energized operation.
 2. The switch assembly shall be snap action or the handle designed to permit checking that a switching operation has been completed.
 3. The switch assembly shall be designed to prevent accidental operation.
 4. Tap positions shall be clearly marked near the switch handle and on the transformer nameplate.
 5. A clearly legible yellow sign in accordance with 9.9c shall be located adjacent to the handle which identifies it as the tap changer handle and includes a warning to not operate energized.
 6. The operating handle for the tap switch shall be located on the tank wall as shown in Figure 1.

8.2 Protection

- a. All transformers require and shall be furnished with the following:
1. A single two-pole or two single-pole low voltage circuit breaker(s) with an overload setting. Circuit breaker calibration shall be verified after installation in the units. The breaker is internally mounted in oil with the operating handle externally operated. The switch position shall be clearly marked on the transformer.
 2. An overload signal light.
 3. An automatic pressure relief valve.
- b. Unless otherwise specified, transformers shall be provided with externally-mounted surge arresters.
1. The arresters shall be rated 12 kV (MCOV 10.2 kV rms).
 2. Two arresters shall be required to be mounted on the mounting pads as shown on Figures 1 and 2.
 3. Arresters shall be provided with connectors for #4 to #2 aluminum or copper conductors.
 4. Arresters shall be normal duty constructed within polymer housing.
- c. All transformers shall be supplied with arrester mounting pads equipped with stainless steel 1-1/4" x 1/2" bolts and washers for mounting surge arresters.
- d. All transformers shall be supplied with a tank ground pad equipped with a ground nut with grounding connector for #4 to #2 copper wires.

EFFECTIVE DATE: 4/4/2018

ISSUED: 

APPROVED: 

 GUAM POWER AUTHORITY	SPECIFICATION No. E-012	Page 8 of 13
		April 4, 2018
PREPARED BY THE ENGINEERING DEPARTMENT		REV. 10

9.0 CONSTRUCTION

- 9.1. The transformer tank, cover, cover band, and associated hardware shall be made of stainless steel.
- a. The manufacturer shall identify the type of steel, and the thickness of the metal in inches or in gage size, in which case he shall specify the gage name.
 - b. Stainless steel shall be type 304L stainless steel and shall be identified by the addition of the words "stainless steel" to the nameplate and the stenciled letters "SS" 3 inches high (minimum) on the tank front below the KVA rating.
 - c. The transformer cover shall have an insulating type coating having a minimum dielectric strength of 15 kV, 60 second withstand.
 - d. The tank shall have a recessed tank bottom which offers protection when sliding over rough surfaces.
 - e. The tank shall have an internal mark which indicates the proper oil level at 25°C per ANSI C57.
 - f. The cover shall be electrically bonded externally to the tank.
 - g. Lifting lugs conforming to ANSI C57 shall be integrally welded to the tank and finish coated with the tank assembly. Lifting provisions shall be arranged in such a manner that a lifting sling will not be in conflict with other transformer parts or accessories and shall permit reasonably balanced lift during handling and installation of the complete unit.
- 9.2. The transformer tank shall be constructed in such a manner as to remain leak proof throughout the life of the transformer.
- 9.3. Transformer covers shall be tightly gasketed and securely clamped to prevent entrance of moisture.
- 9.4. Single-position upper and lower support lugs for direct-pole mounting shall conform to IEEE Standard C57.12.20, except as otherwise specified below and to the requirements stated in Section 1.2, certified to withstand extreme wind loading for sustained wind speeds of 155 MPH and 3 second gusts of 170 mph.
- a. Type B support lugs as defined in IEEE C57.12.20 shall be installed on all transformers regardless of the kVA rating. Support lugs shall be angular and not rectangular. When viewed from the top of the transformer, the edges of the members of the support lug at the point of attachment at the transformer tank to the concavity shall form a 65° angle +/- 10° when measured at the concavity; edges that are parallel from the point of attachment at the transformer tank to the concavity are not acceptable.
 - b. Hanger brackets for all size transformers shall have a concavity at the contact area with the pole such that it conforms to the surface of a concrete pole as shown in Figure 1; the concavity shall comply with IEEE C57.12.20 for Type B support lugs.
- 9.5. Approximate transformer weight and dimensions are provided in Table 3.
- 9.6. The transformer tank shall withstand a static pressure of 50 psig while remaining intact.

EFFECTIVE DATE:

4/4/2018

ISSUED:



APPROVED:





GUAM POWER
AUTHORITY

SPECIFICATION No. E-012

April 4, 2018

PREPARED BY THE ENGINEERING DEPARTMENT

REV. 10

- a. A pressure relief cover design is acceptable relieved at a minimum of 8 psig if designed to reseal.
 - b. The tank may vent at the cover gasket at 15 psig or higher without resealing.
- 9.7. The transformer shall be provided without radiators or cooling fins.
- 9.8. Bushings and Terminals
- a. High voltage bushings shall have a minimum creepage distance of 17 inches.
 - b. Transformer high-voltage and low-voltage bushings shall be glazed wet process porcelain. The color shall be ANSI Z55.1 No. 70 gray.
 - c. Terminals on the high voltage bushings shall conform to ANSI C57. Terminals shall accommodate wire sizes from #4 to #2 copper or aluminum.
 - d. Transformers shall have a minimum clearance of 6 inches from the pole face to any energized part.
 - e. Low voltage terminals shall conform to ANSI C57 and shall be suitable for use with both copper and aluminum conductor sizes from #4 AWG to 250 kcmil. All 167 kVA transformers shall be equipped with 4-bolt NEMA spade terminals.
 - f. The transformer shall consist of three low voltage terminals and shall be suitable for series, three-wire, and parallel operation. The internal leads shall be long enough to easily allow the change of connections for the desired type of operation. The internal secondary leads shall be permanently embossed with the letters A, B, C, and D per ANSI C57. The polarity of the transformer shall be subtractive.
- 9.9. Finish Requirements
- a. The tank, compartment and all appurtenances shall be resistant to impact and corrosion under normal operating conditions in Guam's salt air environment.
 - 1. The color shall be ANSI Z55.1 No. 70 gray
 - 2. The total external dry-film thickness of the paint shall be 3.5 mils minimum or equivalent protection as approved by GPA Engineering.
 - 3. Pressure relief valves may be painted to conform to ANSI Z55.1 No. 70 gray provided painting does not alter the operating characteristics.
 - b. The transformer shall withstand the following environmental tests for 2000 hours:
 - 1. ASTM 8117, Standard Method of Salt Spray (Fog) Testing.
 - 2. ASTM D822, Standard Recommended Practice for Operating Light and Water Exposure Apparatus (Carbon-Arc type) for Testing Paint, Varnish, Lacquer and Related Products (ultraviolet test).
 - 3. ASTM D529, the Accelerated Test of Bituminous Materials.
 - c. Signs for bushing identification and tap positions shall be yellow stenciled or

EFFECTIVE DATE: 4/4/2018

ISSUED: 

APPROVED: 

	GUAM POWER AUTHORITY	SPECIFICATION No. E-012	Page 10 of 13
			April 4, 2018
PREPARED BY THE ENGINEERING DEPARTMENT			REV. 10

approved decals. Decals shall be reflective with black lettering on an amber background, reverse printed on Scotch Cal material with double activated adhesive or an equivalent approved by GPA Engineering.

- d. The transformer kVA rating shall be permanently displayed on the side near the low voltage bushing and on the bottom of the transformer tank with 3 inch high numbers using either paint or labels. Painted numbers shall be black; labels shall be reflective with black lettering on an amber background, reverse printed on Scotch Cal material with double activated adhesive or an equivalent approved by GPA Engineering.
- c. Nameplate
1. The nameplate shall be made of corrosion resistant material and shall comply with applicable industry standards for distribution transformers.
 2. The nameplate shall be permanent showing all of the required information, including KVA, voltage rating, ratio, BIL, weight, winding material, month and year of manufacture, impedance, etc.
 3. The nameplate shall not extend beyond the mounting bracket.
- 9.10. The Supplier shall have information regarding the manufacturing process including general fabrication, assembly, operation and finish available to GPA upon request.
- 9.11. The core and coil shall be vacuum processed to ensure maximum penetration of insulating fluid into the coil insulation system. While under vacuum, the transformer will be filled with preheated filtered degassed insulating fluid. The core shall be manufactured from burr-free, grain-oriented silicon steel and shall be precisely stacked to eliminate gaps in the corner joints. The coil shall be insulated with B-stage, epoxy coated, diamond pattern insulating paper, which shall be thermally cured under pressure to ensure proper bonding of conductor and paper.

10.0 QUALITY CONTROL

- 10.1. The Supplier shall have a quality control program to ensure compliance with the requirements of this specification. The program shall be documented and available for GPA's review if requested.
- 10.2. Documentation of the quality control program shall indicate where in the production and manufacturing process the quality checks are taken, describe the purpose of the checks, and describe the nature of the check, e.g. if check is visual only or if electrical or mechanical testing is used.

11.0 PACKING AND SHIPPING

- 11.1. The supplier shall have adequate work and inspection instructions for handling, storage, preservation, packaging and shipping to protect the quality of the transformer and all attachments and to prevent damage, loss and deterioration of the transformer and its appurtenances.

EFFECTIVE DATE:

4/4/2018

ISSUED:



APPROVED:





GUAM POWER
AUTHORITY

SPECIFICATION No. E-012

April 4, 2018

PREPARED BY THE ENGINEERING DEPARTMENT

REV. 10

- 11.2. The transformer shall be placed and crated with suitable material to prevent damage and injury during shipment and handling operations.
- 11.3. The transformer shall be securely blocked to prevent shifting during transit.

TABLE3
Approximate Transformer Sizes
(See Figure 1 for Dimensions)

Size kVA	Dimensions (inches)				Weight (lbs.)	Gallons of Oil
	A	B	C	D		
5	34	16	19	22	220	6
10	37	16	19	26	233	9
15	39	18	20	23	317	11.5
25	43	20	24	32	410	14
37.5	48	20	24	37	539	16.5
50	49	23	37	33	650	23
75	55	23	28	44	881	34.5
100	55	28.5	31.5	35	1030	42
167	55	28.5	35	43	1340	46

EFFECTIVE DATE: 4/4/2018

ISSUED: 

APPROVED: 



GUAM POWER AUTHORITY

SPECIFICATION No. E-012

April 4, 2018

PREPARED BY THE ENGINEERING DEPARTMENT

REV. 10

FIGURE 1

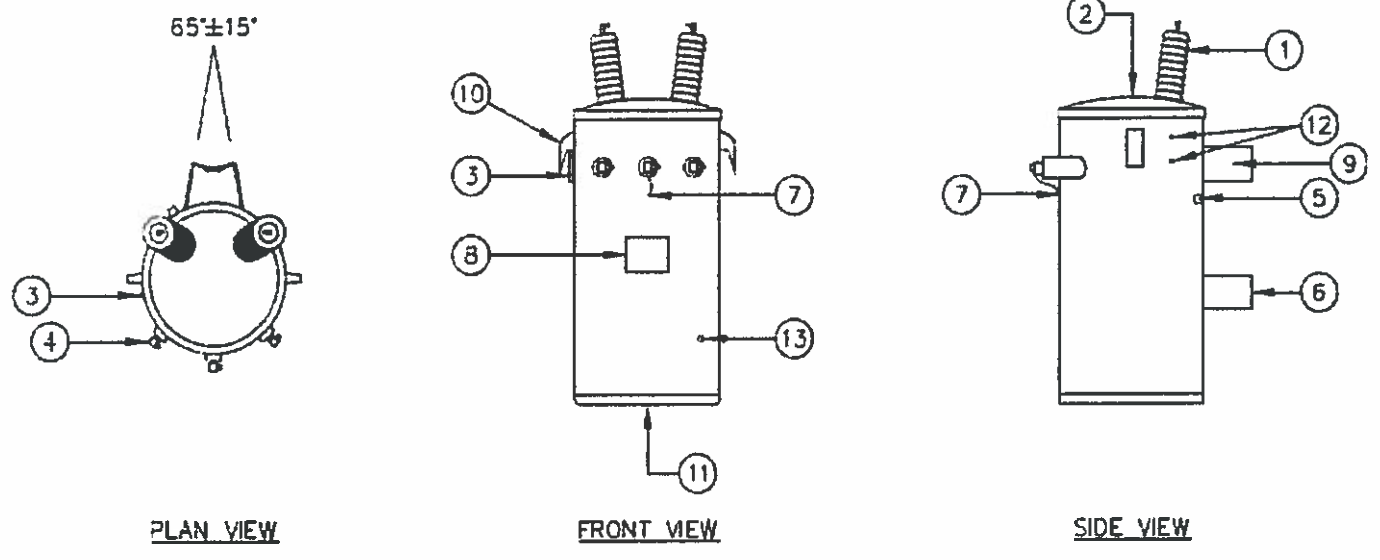

- 1. High Voltage Bushing
- 2. Cover
- 3. Secondary circuit breaker handle and light location
- 4. Low voltage eyebolt terminals
- 5. Tap Changer
- 6. Nameplate (attached to hanger bracket)
- 7. Secondary neutral bushing bonding to tank
- 8. Transformer size decal
- 9. Hanger bracket
- 10. Lifting lugs
- 11. Recessed bottom
- 12. Arrester mounting pads on both sides
- 13. Tank ground pad with grounding connector for #4 to #2 copper wire

EFFECTIVE DATE: 4/4/2018	ISSUED:	APPROVED:
--------------------------	---------	-----------

 <p>GUAM POWER AUTHORITY</p> <p>PREPARED BY THE ENGINEERING DEPARTMENT</p>	<p>SPECIFICATION No. E-012</p>	<p>Page 13 of 13</p>
		<p>April 4, 2018</p>
		<p>REV. 10</p>

FIGURE 2

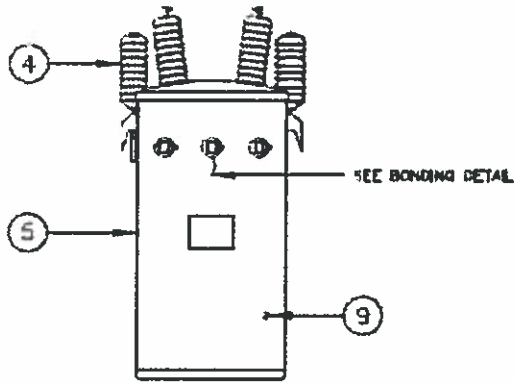

FRONT VIEW

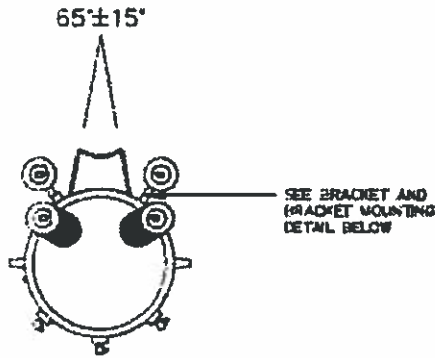

PLAN VIEW

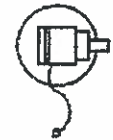

BONDING DETAIL

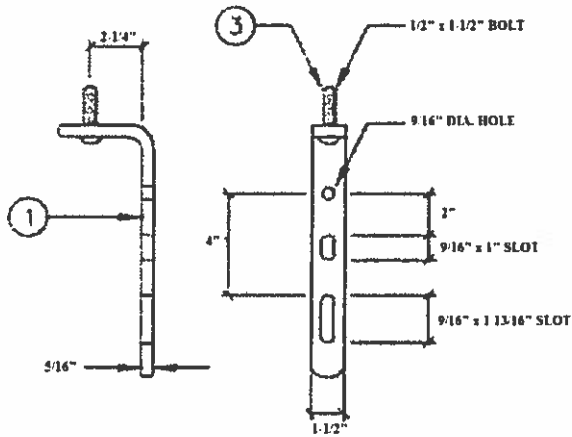

BRACKET DETAIL

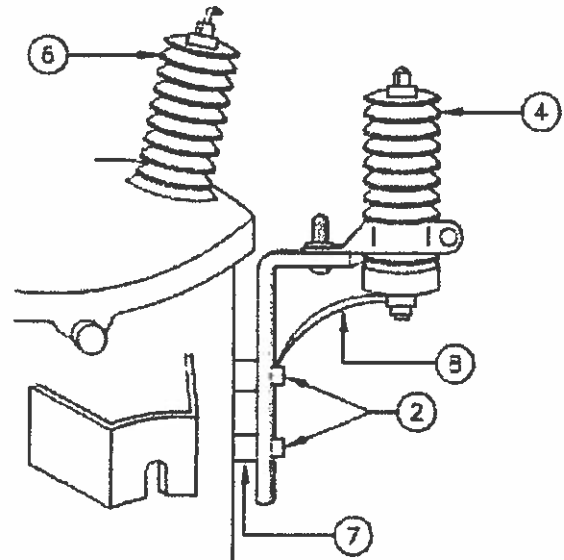

BRACKET MOUNTING DETAIL

1. Arrester Mounting Bracket
2. Bolt
3. Carriage Bolt
4. Surge Arrester
5. Transformer
6. High Voltage Bushing
7. Arrester Mounting Pads
8. Grounding Strap
9. Tank ground pad with grounding connector for #4 to #2 copper wire

EFFECTIVE DATE: 1/14/2018	ISSUED: 	APPROVED: 
---------------------------	---	---



GUAM POWER AUTHORITY

ATURIDÁT ILEKTRESEDÁT GUAHAN
P.O. BOX 2977 · AGANA, GUAM U.S.A. 96932-2977

Lourdes A. Leon Guerrero
I Maga 'håga

Telephone Nos. (671) 648-3054/55 Fax: 648-3165

Joshua F. Tenorio
I Sigundo Maga 'låhi

BID BOND

NO.: _____

KNOW ALL MEN BY THESE PRESENTS that _____, as

Principal Hereinafter called the Principal, and (Bonding Company), _____
A duly admitted insurer under the laws of the Territory of Guam, as Surety, hereinafter called the Surety are
Held firmly bound unto the Territory of Guam for the sum of _____ Dollars
(\$ _____), for Payment of which sum will and truly to be made, the said Principal and the said
Surety bind ourselves, our heirs, executors, administrators, successors and assigns, jointly and severally, firmly
by these presents.

WHEREAS, the Principal has submitted a bid for (identify project by number and brief description)

NOW, THEREFORE, if the Territory of Guam shall accept the bid of the Principal and the Principal shall
enter into a Contract with the Territory of Guam in accordance with the terms of such bid, and give such bond or
bonds as may be specified in bidding or Contract documents with good and sufficient surety for the faithful
performance of such Contract Documents with good and sufficient surety for the faithful performance of such
Contract and for the prompt payment of labor and material furnished in the prosecution thereof, or in the event
of the failure of the Principal to enter such Contract and give such bond or bonds, if the Principal shall pay to the
Territory of Guam the difference not to exceed the penalty hereof between the amounts specified in said bid and
such larger amount for which the Territory of Guam may in good faith contract with another party to perform
work covered by said bid or an appropriate liquidated amount as specified in the Invitation for Bids then this
obligation shall be null and void, otherwise to remain full force and effect.

Signed and sealed this _____ day of _____ 2019.

(PRINCIPAL) (SEAL)

(WITNESS)

(TITLE)

(MAJOR OFFICER OF SURETY)

(TITLE)

(MAJOR OFFICER OF SURETY)

(TITLE)

(RESIDENT GENERAL AGENT)

SEE INSTRUCTIONS FOR SUPPORTING DOCUMENTS REQUIRED.

INSTRUCTION TO PROVIDERS:

NOTICE to all Insurance and Bonding Institutions:

The Bond requires the signatures of the Vendor, two (2) major Officers of the Surety and Resident General Agent, if the Surety is a foreign or alien surety.

When the form is submitted to the Guam Power Authority, it should be accompanied with copies of the following:

1. Current Certificate of Authority to do business on Guam issued by the Department of Revenue and Taxation.
2. Power of Attorney issued by the Surety to the Resident General Agent.
3. Power of Attorney issued by two (2) major officers of the Surety to whoever is signing on their behalf.

Bonds, submitted as Bid Guarantee, without signatures and supporting documents are invalid and Bids will be rejected.



GUAM POWER AUTHORITY

ATURIDÁT ILEKTRESEDÁT GUAHAN
P.O. BOX 2977 · AGANA, GUAM U.S.A. 96932-2977

MAJOR SHAREHOLDERS DISCLOSURE AFFIDAVIT

All Bidders/Offerors are required to submit a current affidavit as required below. Failure to do so will mean disqualification and rejection of the bid/rfp.

5 GCA §5233 (Title 5, Section 5233) states:

"Section 5233 Disclosure of Major Shareholders. As a condition of submitting a bid or offer, any partnership, sole proprietorship or corporation doing business with the government of Guam shall submit an affidavit executed under oath that lists the name and address of any person who has held more than ten percent (10%) of the outstanding interest or shares in said partnership, sole proprietorship or corporation at any time during the twelve (12) month period immediately preceding submission of a bid, or, that it is a not for profit organization that qualifies for tax exemption under the Internal Revenue Code of the United States or the Business Privilege Tax law of Guam, Title 12, Guam Code Annotated, Section 26203©. With the exception of not for profit organizations, the affidavit shall contain the number of shares or the percentage of all assets of such partnership, sole proprietorship or corporation which have held by each such person during the twelve (12) month period. In addition, the affidavit shall contain the name and address of any person who has received or is entitled to receive a commission, gratuity or other compensation for procuring or assisting in obtaining business related to the bid or offer and shall also contain the amounts of any such commission, gratuity or other compensation. The affidavit shall be open and available to the public for inspection and copying."

1. If the affidavit is a copy, indicate the BID/RFP number and where it is filed.
2. Affidavits must be signed within 60 days of the date the bids or proposals are due.

MAJOR SHAREHOLDERS OF DISCLOSURE AFFIDAVIT

TERRITORY OF GUAM)
HAGATNA, GUAM)

I, undersign, _____,
(partner or officer of the company of, etc.)
being first duly sworn, deposes and says:

1. That the person who have held more than ten percent (10%) of the company's shares during the past twelve (12) months are as follows:

<u>Name</u>	<u>Address</u>	<u>Percentage of Shares Held</u>
_____	_____	_____
_____	_____	_____
_____	_____	_____
_____	_____	_____
Total number of shares		_____

2. Persons who have received or are entitled a commission, gratuity or other compensation for procuring or assisting in obtaining business related to the bid/rfp for which this Affidavit is submitted are as follows:

<u>Name</u>	<u>Address</u>	<u>Amount of Commission Gratuity or other Compensation</u>
_____	_____	_____
_____	_____	_____

Further, affiant sayeth naught.

Date: _____

Signature of individual if bidder/offeror is a sole Proprietorship; Partner, if the bidder/offeror is a Partnership Officer, if the bidder/offeror is a corporation.

Subscribe and sworn to before me this _____ day of _____,
20_____.

Notary Public _____
In and for the Territory of Guam
My Commission expires _____.

NON-COLLUSION AFFIDAVIT

Guam)
)ss:
Hagatna)

I, _____ first being duly sworn, depose and say:
(Name of Declarant)

1. That I am the _____ of _____,
(Title) (Name of Bidding/RFP Company)
2. That in making the foregoing proposal or bid, that such proposal or bid is Genuine and not collusive or shame, that said bidder/offeror has not colluded, Conspired, connived or agreed, directly or indirectly, with any bidder or person, to put in a sham or to refrain from bidding or submitting a proposal and has not in any manner, directly or indirectly, sought by agreement or collusion, or communication or conference, with any person, to fix the bid of affiant or any other bidder, or to secure any overhead, project or cost element of said bid price, or of that of any bidder, or to secure any advantage against the GUAM POWER AUTHORITY or any person interested in the proposed contract; and
3. That all statements in said proposal or bid are true.

(Declarant)

SUBSCRIBED AND SWORN to me before this _____ day of _____, 2019

)Seal(

Notary Public

In and for the Territory of Guam

My Commission expires _____.

NO GRATUITIES OR KICKBACKS AFFIDAVIT

AFFIDAVIT
(Offeror)

TERRITORY OF GUAM)

HAGATNA, GUAM)

SS:

_____, being first duly sworn, deposes and says:

As the duly authorized representative of the Offeror, that neither I nor of the Offeror's officers, representatives, agents, subcontractors, or employees has or have offered, given or agreed to give any government of Guam employee or former employee, any payment, gift, kickback, gratuity or offer of employment in connection with Offeror's proposal.

Signature of Individual if Proposer is a Sole Proprietorship;
Partner, if the Proposer is a Partnership;
Officer, if the Proposer is a Corporation

SUBSCRIBED AND SWORN to before me this ____ day of _____, 2019.

Notary Public
In and for the Territory of Guam
My Commission Expires:

ETHICAL STANDARDS AFFIDAVIT

AFFIDAVIT
(Proposer)

TERRITORY OF GUAM)

)

SS:

HAGATNA, GUAM)

)

_____, being first duly sworn, deposes and says:

That I am (the Sole Proprietor, a Partner or Officer of the Offeror)

That Offeror making the foregoing Proposal, that neither he or nor of the Offeror's officers, representatives, agents, subcontractors, or employees of the Offeror have knowingly influenced any government of Guam employee to breach any of the ethical standards set forth in 5 GCA Chapter 5 Article 11, and promises that neither he nor any officer, representative, agent, subcontractor, or employee of Offeror will knowingly influence any government of Guam employee to breach any ethical standard set for in 5 GCA Chapter 5 Article 11.

Signature of Individual if Proposer is a Sole Proprietorship;
Partner, if the Proposer is a Partnership;
Officer, if the Proposer is a Corporation

SUBSCRIBED AND SWORN to before me this ____day of _____, 2019.

Notary Public
In and for the Territory of Guam
My Commission Expires:

DECLARATION RE-COMPLIANCE WITH U.S. DOL WAGE DETERMINATION

Procurement No.: _____

Name of Offeror Company: _____

_____ hereby certifies under penalty of perjury:

(1) That I am _____ (the offeror, a partner of the offeror, an officer of the offeror) making the bid or proposal in the foregoing identified procurement;

(2) That I have read and understand the provisions of 5 GCA § 5801 and § 5802 which read:

§ 5801. Wage Determination Established.

In such cases where the government of Guam enters into contractual arrangements with a sole proprietorship, a partnership or a corporation ('contractor') for the provision of a service to the government of Guam, and in such cases where the contractor employs a person(s) whose purpose, in whole or in part, is the direct delivery of service contracted by the government of Guam, then the contractor shall pay such employee(s) in accordance with the Wage Determination for Guam and the Northern Mariana Islands issued and promulgated by the U.S. Department of Labor for such labor as is employed in the direct delivery of contract deliverables to the government of Guam.

The Wage Determination most recently issued by the U.S. Department of Labor at the time a contract is awarded to a contractor by the government of Guam shall be used to determine wages, which shall be paid to employees pursuant to this Article. Should any contract contain a renewal clause, then at the time of renewal adjustments, there shall be made stipulations contained in that contract for applying the Wage Determination, as required by this Article, so that the Wage Determination promulgated by the U.S. Department of Labor on a date most recent to the renewal date shall apply.

§ 5802. Benefits.

In addition to the Wage Determination detailed in this Article, any contract to which this Article applies shall also contain provisions mandating health and similar benefits for employees covered by this Article, such benefits having a minimum value as detailed in the Wage Determination issued and promulgated by the U.S. Department of Labor, and shall contain provisions guaranteeing a minimum of ten (10) paid holidays per annum per employee.

(3) That the offeror is in full compliance with 5 GCA § 5801 and § 5802, as may be applicable to the procurement referenced herein;

Signature of Individual if Proposer is a Sole Proprietorship;
Partner, if the Proposer is a Partnership;
Officer, if the Proposer is a Corporation

SUBSCRIBED AND SWORN to before me this ____ day of _____, 2019.

Notary Public
In and for the Territory of Guam
My Commission Expires:

SPECIAL PROVISIONS

Restriction Against Sex Offenders Employed by Service Providers to Government of Guam from Working on Government of Guam Property

GCA 5 §5253 Restriction Against Contractors Employing Convicted Sex Offenders from Working at Government of Guam Venues:

- (a) No person convicted of a sex offense under the provisions of Chapter 25 of Title 9 Guam Code Annotated, or an offense as defined in Article 2 of Chapter 28, Title 9 GCA in Guam, or an offense in any jurisdiction which includes, at a minimum, all of the elements of said offenses, or who is listed on the Sex Offender Registry, and who is employed by a business contracted to perform services for an agency or instrumentality of the government of Guam, shall work for his employer on the property of the Government of Guam other than public highway.
- (b) All contracts for services to agencies listed herein shall include the following provisions: (1) warranties that no person providing services on behalf of the contractor has been convicted of a sex offense under the provisions of Chapter 25 of Title 9 GCA or an offense as defined in Article 2 of Chapter 28, Title 9 GCA, or an offense in another jurisdiction with, at a minimum, the same elements as such offenses, or who is listed on the Sex Offender Registry; and (2) that if any person providing services on behalf of the contractor is convicted of a sex offense under the provisions of Chapter 25 of Title 9 GCA or an offense as defined in Article 2 of Chapter 28, Title 9 GCA or an offense in another jurisdiction with, at a minimum, the same elements as such offenses, or who is listed on the Sex Offender Registry, that such person will be immediately removed from working at said agency and that the administrator of said agency be informed of such within twenty-four (24) hours of such conviction.
- (c) Duties of the General Services Agency or Procurement Administrators. All contracts, bids, or Requests for Proposals shall state all the conditions in § 5253(b).
- (d) Any contractor found in violation of § 5253(b), after notice from the contracting authority of such violation, shall, within twenty-four (24) hours, take corrective action and shall report such action to the contracting authority. Failure to take corrective action within the stipulated period may result in the temporary suspension of the contract at the discretion of the contracting authority.

SOURCE: Added by P.L. 28-024:2 ((Apr. 21, 2005). Amended by P.L. 28-098:2 (Feb. 7, 2006).

Signature of Bidder Date

Proposer, if an individual;
Partner, if a partnership;
Officer, if a corporation.

Subscribed and sworn before me this _____ day of _____, 2019.

Notary Public



GUAM POWER AUTHORITY

ATURIDÁT ILEKTRESEDÁT GUAHAN
P.O. BOX 2977 · AGANA, GUAM U.S.A. 96932-2977

Lourdes A. Leon Guerrero
I Maga 'hâga

Telephone Nos. (671) 648-3054/55 Fax: 648-3165

Joshua F. Tenorio
I Sigundo Maga 'lâhi

Accountability · Impartiality · Competence · Openness · Value

LOCAL PROCUREMENT PREFERENCE APPLICATION

Based on the law stipulated below, please place a checkmark or an "X" on the block indicating the item that applies to your business:

5GCA, Chapter 5, Section 5008, "Policy in Favor of Local Procurement" of the Guam Procurement Law states:

All procurement of supplies and services shall be made from among businesses licensed to do business on Guam and that maintains an office or other facility on Guam, whenever a business that is willing to be a contractor is:

- () (a) A licensed bonafide manufacturing business that adds at least twenty-five percent (25%) of the value of an item, not to include administrative overhead, suing workers who are U.S. Citizens or lawfully admitted permanent residents or nationals of the United States, or persons who are lawfully admitted to the United States to work, based on their former citizenship in the Trust Territory for the Pacific Islands; or
- () (b) A business that regularly carries an inventory for regular immediate sale of at least fifty percent (50%) of the items of supplies to be procured; or
- () (c) A business that has a bonafide retail or wholesale business location that regularly carries an inventory on Guam of a value of at least one half of the value of the bid or One Hundred Fifty Thousand Dollars (\$150,000.0) whichever is less, of supplies and items of a similar nature to those being sought; or
- () *(d) A service actually in business, doing a substantial business on Guam, and hiring at least 95% U.S. Citizens, lawfully admitted permanent residents or national of the Unites States, or persons who lawfully admitted to the United States to work, based on their citizenship in any of the nations previously comprising the Trust Territory of the Pacific Islands.

- Bidders indicating qualification under (d) may be considered QUALIFIED for the Local Procurement Preference only if the Government's requirement is for service. Service is defined Pursuant to 5 GCA Government Operations Subparagraph 5030 entitled DEFINITIONS under Chapter 5 of the Guam Procurement Law.

1. I _____, representative for _____, have read the requirements of the law cited above and do hereby qualify and elect to be given the LOCAL PROCUREMENT PREFERENCE for Bid No.: GPA _____. By filling in this information and placing my signature below, I understand that the Guam Power Authority will review this application and provide me with a determination whether or not the 15% preference will be applied to this bid.
2. I _____, representative for _____, have read the requirements of the law cited above, and do not wish to apply for the Local Procurement Preference for Bid No.: GPA _____.

Bidder Representative Signature

Date

NOTE:

Prospective Bidders not completing this form will automatically be not considered for Local Procurement Preference. Non-completion of this form is not a basis for rejection of the bid or proposal.

GOVERNMENT OF GUAM

GENERAL TERMS AND CONDITIONS

SEALED BID SOLICITATION AND AWARD

Only those Boxes checked below are applicable to this bid.

1. **AUTHORITY:** This solicitation is issued subject to all the provision of the Guam Procurement Act (5GCA, Chapter 5) And the Guam Procurement Regulations (copies of both are available at the Office of the Complier of laws, Department of Law, copies available for inspection at the Guam Power Authority). It requires all parties involved in the Preparation, negotiation, performance, or administration of contracts to act in good faith.
2. **GENERAL INTENTION:** Unless otherwise specified, it is the declared and acknowledged intention and meaning of these General Terms and conditions for the bidder to provide the Government of Guam (Government) with specified services or with materials, supplies or equipment completely assembled and ready for use.
3. **TAXES:** Bidders are cautioned that they are subject to Guam Income Taxes as well as all other taxes on Guam Transactions. Specific information on taxes may be obtained from the Director of Revenue and Taxation.
4. **LICENSING:** Bidders are cautioned that the Government will not consider for award any offer submitted by a bidder who has not complied with the Guam Licensing Law. Specific information on licenses may be obtained from the Director of Revenue and Taxation.
5. **LOCAL PROCUREMENT PREFERENCE:** All procurement of supplies and services where possible, will be made from among businesses licensed to do business on Guam in accordance with section 5008 of the Guam Procurement Act (5GCA, Chapter 5) and Section 1-104 of the Guam Procurement Regulations.
6. **COMPLIANCE WITH SPECIFICATIONS AND OTHER SOLICITATION REQUIREMENTS:** Bidders shall comply with all specifications and other requirements of the Solicitation.
7. **“ALL OR NONE” BIDS:** Unless otherwise allowed under this Solicitation. “all or none” bids may be deemed to be non-responsive. If the bid is so limited, the Government may reject part of such proposal and award on the remainder.

NOTE: By checking this item, the Government is requesting all of the bid items to be bid or none at all. **The Government will not award on an itemized basis.** Reference: Section 3-101.06 of the Guam Procurement Regulations.

8. **INDEPENDENT PRICE DETERMINATION:** The bidder, upon signing the Invitation for Bid, certifies that the prices in his bid were derived at without collusion, and acknowledge that collusion and anti-competitive practices are prohibited by law. Violations will be subject to the provision of Section 5651 of that of the Guam Procurement Act. Other existing civil, criminal or administrative remedies are not impaired and may be in addition to the remedies in Section 5651 of the Government code.
9. **BIDDER’S PRICE:** The Government will consider not more than two (2) (Basic and Alternate) item prices and the bidder shall explain fully each price if supplies, materials, equipment, and/or specified services offered comply with specifications and the products origin. Where basic or alternate bid meets the minimum required specification, cost and other factors will be considered. Failure to explain this requirement will result in rejection of the bid.
10. **BID ENVELOPE:** Envelope shall be sealed and marked with the bidder’s name, Bid number, time, date and place of Bid Opening.
11. **BID GUARANTEE REQUIREMENT:** Bidder is required to submit a Bid Guarantee Bond or standby irrevocable Letter of Credit or Certified Check or Cashier’s Check in the same bid envelope to be held by the Government pending award. The Letter of Credit, Cash, Certified Check or Cashier’s Check, Bid Guarantee Bond must be issued by any local surety or banking institution licensed to do business on Guam and made payable to the Guam Power Authority in the amount of fifteen percent (15%) of his highest total bid offer. The Bid Bond must be submitted on Government Standard Form BB-1 (copy enclosed). Personal Checks will not be accepted as Bid Guarantee. If a successful Bidder (contractor) withdraws from the bid or fails to enter into contract within the prescribed time, such Bid guarantee will be forfeited to the Government of Guam. Bids will be disqualified if not accompanied by Bid Bond, Letter of Credit, Certified Check or Cashier’s check. Bidder must include in his/her bid, valid copies of a Power of Attorney from the Surety and a Certificate of Authority from the Government of Guam to show proof that the surety company named on the bond instrument is authorized by the Government of Guam and qualified to do business on Guam. For detailed information on bonding matters, contact the Department of Revenue and Taxation. Failure to submit a valid Power of Attorney and Certificate of Authority on the surety is cause for rejection of bid. (GPR Section 3-202.03.3) **Pursuant to Public Law 27-127, all competitive sealed bidding for the procurement of supplies or services exceeding \$25,000.00 a 15% Bid Security of the total bid price must accompany the bid package.**
12. **PERFORMANCE BOND REQUIREMENT:** The Bidder may be required to furnish a Performance Bond on Government Standard Form BB-1 or standby irrevocable Letter of Credit or Certified Check or Cashier’s Check payable to the Guam Power Authority issued by any of the local Banks or Bonding Institution in the amount of **Fifteen Percent (15%)** for that full or partial fiscal year within the term of the contract. In the event that any of the provisions of this contract are violated by the contractor, the Chief Procurement Officer shall serve written notice upon both the contractor and the Surety of its intention to terminate the contract. Unless satisfactory arrangement or correction is made with ten (10) days of such notice the contract shall cease and terminate upon the expiration of the ten (10) days. In the event of any such termination, the Chief Procurement Officer shall immediately serve notice thereof upon the Surety. The Surety shall have the right to take over and perform the contract, provided, however, that if the Surety does not commence performance thereof within 10 days from the date of the mailing of notice of termination, the Government may take over and prosecute the same to complete the contract or force account for the account and at the expense of the contractor, and the contractor and his Surety shall be liable to the Government for any excess cost occasioned the Government thereby (GPR Section 3-202.03.4).

- [X] 13. **PERFORMANCE GUARANTEE:** Bidders who are awarded a contract under this solicitation, guarantee that goods will be delivered or required services performed within the time specified. Failure to perform the contract in a satisfactory manner may be cause for suspension or debarment from doing business with the Government and to enforce Section 23 of these General Terms and Conditions. In addition, the Government will hold the Vendor liable and will enforce the requirements as set forth in Section 41 of these General Terms and Conditions.
- [X] 14. **SURETY BONDS:** Bid and Performance Bonds coverage must be signed or countersigned in Guam by a foreign or alien surety's resident general agent. The surety must be an Insurance Company, authorized by the government of Guam and qualified to do business in Guam. Bids will be disqualified if the Surety Company does not have a valid Certificate of Authority from the Government of Guam to conduct business in Guam.
- [X] 15. **COMPETENCY OF BIDDERS:** Bids will be considered only from such bidders who, in the opinion of the Government, can show evidence of their ability, experience, equipment, and facilities to render satisfactory service.
- [X] 16. **DETERMINATION OF RESPONSIBILITY OF BIDDERS:** The Chief Procurement Officer reserves the right for securing from bidders information to determine whether or not they are responsible and to inspect plant site, place of business; and supplies and services as necessary to determine their responsibility in accordance with Section 15 of these General Terms and Conditions (GPR Section 3-401).
- [X] 17. **STANDARD FOR DETERMINATION OF LOWEST RESPONSIBLE BIDDER:** In determining the lowest responsible offer, the Chief Procurement Officer shall be guided by the following:
- a) Price of items offered.
 - b) The ability, capacity, and skill of the Bidder to perform.
 - c) Whether the Bidder can perform promptly or within the specified time.
 - d) The quality of performance of the Bidder with regards to awards previously made to him.
 - e) The previous and existing compliance by the Bidder with laws and regulations relative to procurement.
 - f) The sufficiency of the financial resources and ability of the Bidder to perform.
 - g) The ability of the bidder to provide future maintenance and services for the subject of the award.
 - h) **The compliance with all of the conditions to the Solicitation.**
- [X] 18. **TIE BIDS:** If the bids are for the same unit price or total amount in the whole or in part, the Chief Procurement Officer will determine award based on Section 3.202.15.2, or to reject all such bids (GPR Section 3-202.15.2).
- [] 19. **BRAND NAMES:** Any reference in the Solicitation to manufacturer's Brand Names and number is due to lack of a satisfactory specification of commodity description. Such preference is intended to be descriptive, but not restrictive and for the sole purpose of indicating prospective bidders a description of the article or services that will be satisfactory. Bids on comparable items will be considered provided the bidder clearly states in his bid the exact articles he is offering and how it differs from the original specification.
- [X] 20. **DESCRIPTIVE LITERATURE:** Descriptive literature(s) as specified in this solicitation must be furnished as a part of the bid and must be received at the date and time set for opening Bids. The literature furnished must clearly identify the item(s) in the Bid. The descriptive literature is required to establish, for the purpose of evaluation and award, details of the product(s) the bidder proposes to furnish including design, materials, components, performance characteristics, methods of manufacture, construction, assembly or other characteristics which are considered appropriate. Rejection of the Bid will be required if the descriptive literature(s) do not show that the product(s) offered conform(s) to the specifications and other requirements of this solicitation. Failure to furnish the descriptive literature(s) by the time specified in the Solicitation will require rejection of the bid.
- [] 21. **SAMPLES:** Sample(s) of item(s) as specified in this solicitation must be furnished as a part of the bid and must be received at the date and time set for opening Bids. The sample(s) should represent exactly what the bidder proposes to furnish and will be used to determine if the item(s) offered complies with the specifications. Rejection of the Bid will be required if the sample(s) do not show that the product(s) offered conform(s) to the specifications and other requirements of this solicitation. Failure to furnish the sample(s) by the time specified in the Solicitation will require rejection of the Bid.
- [] 22. **LABORATORY TEST:** Successful bidder is required to accompany delivery of his goods with a Laboratory Test Report indicating that the product he is furnishing the Government meets with the specifications. This report is on the bidder's account and must be from a certified Testing Association.
- [X] 23. **AWARD, CANCELLATION, & REJECTION:** Award shall be made to the lowest responsible and responsive bidder, whose bid is determined to be the most advantageous to the Government, taking into consideration the evaluation factors set forth in this solicitation. No other factors or criteria shall be used in the evaluation. The right is reserved as the interest of the Government may require to waive any minor irregularity in bid received. The Chief Procurement Officer shall have the authority to award, cancel, or reject bids, in whole or in part for any one or more items if he determines it is in the public interest. Award issued to the lowest responsible bidder within the specified time for acceptance as indicated in the solicitation, results in a bidding contract without further action by either party. In case of an error in the extension of prices, unit price will govern. It is the policy of the Government to award contracts to qualified local bidders. The government reserves the right to increase or decrease the quantity of the items for award and make additional awards for the same type items and the vendor agrees to such modifications and additional awards based on the bid prices for a period of thirty (30) days after original award. No award shall be made under this solicitation which shall require advance payment or irrevocable letter of credit from the government (GPR Section 3-202.14.1).
- [X] 24. **MARKING:** Each outside container shall be marked with the Purchase Order number, item number, brief item description and quantity. Letter marking shall not be less than 3/4" in height.
- [X] 25. **SCHEDULE FOR DELIVERY:** Successful bidder shall notify the Guam Power Authority Dededo Warehouse at (671) 653-2073, Information Technology Division at (671) 648-3060, and/or Guam Power Authority Cabras Warehouse at (671) 475-3319, at least twenty-four (24) hours before delivery of any item under this solicitation.
- [X] 26. **BILL OF SALE:** Successful supplier shall render Bills of Sale for each item delivered under this contract. Failure to comply with this requirement will result in rejection of delivery. The Bill of Sale must accompany the items delivered but will not be considered as an invoice for payment. Supplier shall bill the Government in accordance with billing instructions as indicated on the Purchase Order.

- [X] 27. **MANUFACTURER'S CERTIFICATE:** Successful bidder is required, upon delivery of any item under this contract, to furnish a certificate from the manufacturer indicating that the goods meet the specifications. Failure to comply with this request will result in rejection of delivery payment. Supplier shall bill the Government in accordance with billing instructions as indicated on the Purchase Order.
- [X] 28. **INSPECTION:** All supplies, materials, equipment, or services delivered under this contract shall be subject to the inspection and/or test conducted by the Government at destination. If in any case the supplies, materials, equipment, or services are found to be defective in material, workmanship, performance, or otherwise do not conform with the specifications, the Government shall have the right to reject the items or require that they be corrected. The number of days required for correction will be determined by the Government.
- [] 29. **MOTOR VEHICLE SAFETY REQUIREMENTS:** The Government will only consider Bids on motor vehicles which comply with the requirements of the National Traffic and Motor Vehicle safety Act of 1966 (Public Law 89-563) and Clean Air Act as amended (Public Law 88-206), that are applicable to Guam. Bidders shall state if the equipment offered complies with these aforementioned Federal Laws.
- [] 30. **SAFETY INSPECTION:** All motor vehicles delivered under this contract must pass the Government of Guam Vehicle Inspection before delivery at destination.
- [X] 31. **GUARANTEE:**
- a) **Guarantee of Vehicle Type of Equipment:**
The successful bidder shall guarantee vehicular type of equipment offered against defective parts, workmanship, and performance, for a period of not less than one (1) year after date of receipt of equipment. Bidder shall also provide service to the equipment for at least one (1) year. Service to be provided shall include, but will not be limited to tune ups (change of spark plugs, contact points and condensers) and lubrication (change of engine and transmission oil). All parts and labor shall be at the expense of the bidder. All parts found defective and not caused by misuse, negligence or accident within the guarantee period shall be repaired, replaced, or adjusted within six (6) working days after notice from the Government and without cost to the Government. Vehicular type of equipment as used in this context shall include equipment used for transportation as differentiated from tractors, backhoes, etc.
- b) **Guarantee of Other Type of Equipment:**
The successful bidder shall guarantee all other types of equipment offered, except those mentioned in 31a, above, against defective parts, workmanship, and performance for a period of not less than three (3) months after date of receipt of equipment. Bidder shall also provide service to the equipment for at least three (3) months. All parts found defective within that period shall be repaired or replaced by the Contractor without cost to the Government. Repairs, adjustments or replacements of defective parts shall be completed by the contractor within six (6) working days after notice from the Government.
- c) **Compliance with this Section is a condition of this Bid.**
- [X] 32. **REPRESENTATION REGARDING ETHICS IN PUBLIC PROCUREMENT:** The bidder or contractor represents that it has not knowingly influenced and promises that it will not knowingly influence a Government employee to breach any of the ethical standards and represents that it has not violated, is not violating, and promises that it will not violate the prohibition against gratuities and kickbacks set forth on Chapter 11 (Ethics in Public Contracting) of the Guam Procurement Act and in Chapter 11 of the Guam Procurement Regulations.
- [X] 33. **REPRESENTATION REGARDING CONTINGENT FEES:** The contractor represents that it has not retained a person to solicit or secure a Government contract upon an agreement or understanding for a commission, percentage, brokerage, or contingent fee, except for retention of bona fide employees or bona fide established commercial selling agencies for the purpose of securing business (GPR Section 11-207).
- [X] 34. **EQUAL EMPLOYMENT OPPORTUNITY:** Contractors shall not discriminate against any employee or applicant of employment because of race, color, religion, sex, or national origin. The contractor will take affirmative action to ensure that employees are treated equally during employment without regard to their race, color, religion, sex, or national origin.
- [X] 35. **COMPLIANCE WITH LAWS:** Bidders awarded a contract under this Solicitation shall comply with the applicable standard, provisions, and stipulations of all pertinent Federal and/or local laws, rules, and regulations relative to the performance of this contract and the furnishing of goods.
- [] 36. **CHANGE ORDER:** Any order issued relative to awards made under this solicitation will be subject to and in accordance with the provisions of Section 6-101-03.1 of the Guam Procurement Regulations.
- [] 37. **STOP WORK ORDER:** Any stop work order issued relative to awards made under this solicitation will be subject to and in accordance with the provisions of Section 6-101-04.1 of the Guam Procurement Regulations.
- [X] 38. **TERMINATION FOR CONVENIENCE:** Any termination order for the convenience of the Government issued relative to awards made under this solicitation will be subject to and in accordance with the provisions of Section 6-101.10 of the Government Procurement Regulations.
- [X] 39. **TIME FOR COMPLETION:** It is hereby understood and mutually agreed by and between the contractor and the Government that the time for delivery to final destination or the timely performance of certain services is an essential condition of this contract. If the contractor refuses or fails to perform any of the provisions of this contract within the time specified in the Purchase Order (from the date Purchase Order is acknowledged by vendor), then the contractor is in default. Defaults will be treated subject to and in accordance with the provisions of Section 6-101-08 of the Guam Procurement Regulations.
- [X] 40. **JUSTIFICATION OF DELAY:** Bidders who are awarded contracts under this Solicitation, guarantee that the goods will be delivered to their destination or required services rendered within the time specified. If the bidder is not able to meet the specified delivery date, he is required to notify the Chief Procurement Officer of such delay. Notification shall be in writing and shall be received by the Chief Procurement Officer at least twenty-four (24) hours before the specified delivery date. Notification of

delay shall include an explanation of the causes and reasons for the delay including statement(s) from supplier or shipping company causing the delay. The Government reserves the right to reject delay justification if, in the opinion of the Chief Procurement Officer, such justification is not adequate.

[X] 41. **LIQUIDATED DAMAGES:** When the contractor is given notice of delay or nonperformance as specified in Paragraph 1 (Default) of the Termination for Default Clause of this contract and fails to cure in the time specified, the contractor shall be liable for damages for delay in the amount of one-fourth of one percent (1%) of outstanding order per calendar day from date set for cure until either the territory reasonable obtains similar supplies or services if the contractor is terminated for default, or until the contractor provides the supplies or services if the contractor is not terminated for default. To the extent that the contractor's delay or nonperformance is excused under Paragraph 40 (Excuse for Nonperformance or Delayed Performance) of the Termination for Default Clause of this contract, liquidated damages shall not be due the territory. The contractor remains liable for damages caused other than by delay (GPR Section 6-101-09.1).

[X] 42. **PHYSICAL LIABILITY:** If it becomes necessary for the Vendor, either as principal, agent or employee, to enter upon the premises or property of the Government of Guam in order to construct, erect, inspect, make delivery or remove property hereunder, the Vendor hereby covenants and agrees to take, use, provide and make all proper, necessary and sufficient precautions, safeguards and protections against the occurrence of any accidents, injuries or damages to any person or property during the progress of the work herein covered, and to be responsible for, and to indemnify and save harmless the Government of Guam from the payment of all sums of money by reason of all or any such accidents, injuries or damages that may occur upon or about such work, and fines, penalties and loss incurred for or by reasons of the violations of any territorial ordinance, regulations, or the laws of Guam or the United States, while the work is in progress. Contractor will carry insurance to indemnify the Government of Guam against any claim for loss, damage or injury to property or persons arising out of the performance of the Contractor or his employees and agents of the services covered by the contract and the use, misuse or failure of any equipment used by the contractor or his employees or agents, and shall provide certificates of such insurance to the Government of Guam when required.

[X] 43. **CONTACT FOR CONTRACT ADMINISTRATION:** If your firm receives a contract as a result of this Solicitation, please designate a person whom we may contact for prompt administration.

Name: _____ Title: _____

Address: _____ Telephone: _____

GOVERNMENT OF GUAM

SEALED BID SOLICITATION INSTRUCTIONS

1. **BID FORMS:** Each bidder shall be provided with two (2) sets of Solicitation forms. Additional copies may be provided upon request. Bidders requesting additional copies of said forms will be charged per page in accordance with Section 6114 of the Government Code of Guam. All payments for this purpose shall be by cash, certified check or money order and shall be made payable to the Guam Power Authority.

2. **PREPARATIONS OF BIDS:**
 - a) Bidders are required to examine the drawings, specifications, schedule, and all instructions. Failure to do so will be at bidder's risk.
 - b) Each bidder shall furnish the information required by the Solicitation. The bidder shall sign the solicitation and print or type his name on the Schedule. Erasures or other changes must be initialed by the person signing the bid. Bids signed by an agent are to be accompanied by evidence of this authority unless such evidence has been previously furnished to the issuing office.
 - c) Unit price for each unit offered shall be shown and such price shall include packing unless otherwise specified. A total shall be entered in the amount column of the Schedule for each item offered. In case of discrepancies between a unit price and extended price, the unit price will be presumed to be correct.
 - d) Bids for supplies or services other than those specified will not be considered.
Time, if stated as a number of days, means calendar days and will include Saturdays, Sundays, and holidays beginning the day after the issuance of a Notice to Proceed. Time stated ending on a Saturday, Sunday or Government of Guam legal holiday will end at the close of the next business day.

3. **EXPLANATION TO BIDDERS:** Any explanation desired by a bidder regarding the meaning or interpretation of the Solicitation, drawings, specifications, etc., must be submitted in writing and with sufficient time allowed for a written reply to reach all bidders before the submission of their bids. Oral explanations or instructions given before the award of the contract will not be binding. Any information given to a prospective bidder concerning a Solicitation will be furnished to all prospective bidders in writing as an amendment to the Solicitation if such information would be prejudicial to uninformed bidders.

4. **ACKNOWLEDGEMENT OF AMENDMENTS TO SOLICITATIONS:** Receipt of an amendment to a Solicitation by a bidder must be acknowledged by signing an acknowledgement of receipt of the amendment.
Such acknowledgement must be received prior to the hour and date specified for receipt of bids.

5. **SUBMISSION OF BIDS:**
 - a) Bids and modifications thereof shall be enclosed in sealed envelopes and addressed to the office specified in the Solicitation. The bidder shall show the hour and date specified in the Solicitation for receipt, the Solicitation number, and the name and address of the bidder on the face of the envelope.
 - b) Telegraphic bids will not be considered unless authorized by the Solicitation. However, bids may be modified or withdrawn by written or telegraphic notice, provided such notice is received prior to the hour and date specified for receipt (see paragraph 6 of these instructions).
 - c) Samples of items, when required, must be submitted within the time specified, unless otherwise specified by the Government, at no expense to the Government. If not destroyed by testing, samples will be returned at bidder's request and expense, unless otherwise specified by the Solicitation.
 - d) Samples or descriptive literature should not be submitted unless it is required on this solicitation. Regardless of any attempt by a bidder to condition the bid, unsolicited samples or descriptive literature will not be examined or tested at the bidder's risk, and will not be deemed to vary any of the provisions of this Solicitation.

6. **FAILURE TO SUBMIT BID:** If no bid is to be submitted, do not return the solicitation unless otherwise specified. A letter or postcard shall be sent to the issuing office advising whether future Solicitations for the type of supplies or services covered by this Solicitation are desired.

7. **LATE BID, LATE WITHDRAWALS, AND LATE MODIFICATIONS:**
 - a) Definition: Any bid received after the time and date set for receipt of bids is late. Any withdrawal or modification of a bid received after the time and date set for opening of bids at the place designated for opening is late (Guam Procurement Regulations Section 3-202)
 - b) Treatment: No late bid, late modification, or late withdrawal will be considered unless received before contract award, and the bid, modification, or withdrawal would have been timely but for the action or inaction of territorial personnel directly serving the procurement activity.

8. **DISCOUNTS:**
 - a) Notwithstanding the fact that prompt payment discounts may be offered, such offer will not be considered in evaluating bids for award unless otherwise specified in the Solicitation. However, offered discounts will be taken if payment is made within the discount period, even though not considered in the evaluation of bids.

b) In connection with any discount offered, time will be computed from date of delivery and acceptance of the supplies to the destination as indicated in the purchase order or contract. Payment is deemed to be made for the purpose of earning the discount on the date of mailing of the Government check.

9. **GOVERNMENT FURNISHED PROPERTY:** No material, labor or facilities will be furnished by the Government unless otherwise provided for in the Solicitation.
10. **SELLERS' INVOICES:** Invoices shall be prepared and submitted in quadruplicate (one copy shall be marked "original") unless otherwise specified. Invoices shall be "certified true and correct" and shall contain the following information: Contract and order number (if any), item numbers, description of supplies or services, sizes, quantities, unit prices, and extended total. Bill of lading number and weight of shipment will be shown for shipments made on Government bills of lading.
11. **RECEIPT, OPENING AND RECORDING OF BIDS:** Bids and modifications shall be publicly opened in the presence of one or more witnesses, at the time, date, and place designated in the Invitation for Bids. The name of each bidder, the bid price, and such other information as is deemed appropriate by the Procurement Officer, shall be read aloud and recorded, or otherwise made available. The names and addresses of required witnesses shall be recorded at the opening. The opened bids shall be available for public inspection except to the extent the bidder designates trade secrets or other proprietary data to be confidential as set forth in accordance with Section 12 below. Material so designated shall accompany the bid and shall be readily separable from the bid in order to facilitate public inspection of the non-confidential portion of the bid. Prices, makes and models or catalogue numbers of the items offered, deliveries, and terms of payment shall be publicly available at the time of bid opening regardless of any designation to the contrary (Guam Procurement Regulations Section 3-202.12.2).
12. **CONFIDENTIAL DATA:** The Procurement Officer shall examine the bids to determine the validity of any requests for nondisclosure of trade secrets and other proprietary data identified in writing. If the parties do not agree as to the disclosure of data, the Procurement Officer shall inform the bidders in writing what portions of the bid will be disclosed and that, unless the bidders protest under Chapter 9 of the Guam Procurement Act (P.L. 16-124), the bids will be so disclosed. The bids shall be opened to public inspection subject to any continuing prohibition on the disclosure of confidential data (Guam Procurement Regulations Section 3-202.12.3).
13. **MULTI-STEP SEALED BIDDING:**
- a. It is defined as two-phase process consisting of a technical first-phase composed of one or more steps in which bidders submit unpriced technical offers to be evaluated by the territory, and a second-phase in which those bidders whose technical offers are determined to be acceptable during the first-step have their priced bids considered. It is designed to obtain the benefits of competitive sealed bidding by award of a contract to the lowest responsive, responsible bidder, and at the same time obtained the benefits of the competitive sealed proposals procedure through the solicitation of technical offers and the conduct of discussions to evaluate and determine the acceptability of technical offers.
 - b. In addition to the requirements set forth in the General Terms and Conditions and the Special provisions, the following applies:
 - 1). only unpriced technical offers are requested in the first phase;
 - 2). priced bids will be considered only in the second phase and only from bidders whose unpriced technical offers are found acceptable in the first phase;
 - 3). the criteria to be used in the evaluation at those specified in the Special Provisions and the General Terms and Conditions;
 - 4). the territory, to the extent the Procurement Officer finds necessary, may conduct oral or written discussion of the unpriced technical offers;
 - 5). the bidders, may designate those portions of the unpriced technical offers which contain trade secrets or other proprietary data which are to remain confidential; and,
 - 6). the service being procured shall be furnished generally in accordance with bidder's technical offer as found to be finally acceptable and shall meet the requirements of the Invitation for Bids.
 - c. **RECEIPT AND HANDLING OF UNPRICED TECHNICAL OFFERS.**
Unpriced technical offers shall not be opened publicly, but shall be opened in front of two or more procurement officials. Such offers shall not be disclosed to unauthorized persons. Bidders may request nondisclosure of trade secrets and other proprietary data identified in writing.
 - d. **EVALUATION OF UNPRICED TECHNICAL OFFERS.**
The unpriced technical offers submitted by bidders shall be evaluated solely in accordance with the criteria set forth in the Invitation for Bids. The unpriced technical offers shall be categorized as:
 - 1). acceptable;
 - 2). potentially acceptable, that is, reasonably susceptible of being made acceptable; or
 - 3). unacceptable. The Procurement Officer shall record in writing the basis for finding an offer unacceptable and make it part of the procurement file.

The Procurement Officer may initiate Phase Two of the procedure if, in the Procurement Officer's opinion, there are sufficient acceptable unpriced technical offers to assure effective price competition in the second phase without technical discussions. If the Procurement Officer finds such is not the case, the Procurement Officer shall issue an amendment to the Invitation for Bids or engage in technical discussions as set forth in Subsection 3-202.20.5 of this Section.
 - e. Upon the completion of Phase One, the Procurement Officer shall invite each acceptable bidder to submit a price bid. Upon submission of prices, the Procurement Officer shall prepare the final evaluation and reconsideration for the Chief Procurement Officer's approval.